

# **ATOM 3.0**

## **DIVE COMPUTER**

# **OPERATING MANUAL**

CONTENTS

WARRANTY, NOTICES, MODEL .....	3	SELECT DIVE OP MODE .....	24
FEATURES/FUNCTIONS AND WATCH MODE .....	5	HISTORY MODE (NORM/GAUG).....	24
DISPLAY ICONS .....	6	SERIAL NUMBER.....	24
ABBREVIATIONS/TERMS .....	6	BATTERY/TMT STATUS.....	24
OVERVIEW .....	7	DIVE MODE FEATURES .....	26
SELECTION GROUPS .....	7	TRANSMITTER SIGNAL RECEPTION GUIDE.....	27
BACKLIGHT .....	7	PROXIMITY OF TMTS TO THE ATOM 3.0.....	27
AUDIBLE ALARM.....	8	Link Interruption Underwater .....	27
PC INTERFACE .....	8	BAR GRAPHS .....	28
POWER SUPPLY .....	9	TLBG (NORM/FREE).....	28
BATTERY STATUS .....	9	VARI (NORM/GAUG).....	28
WATCH MAIN (DEFAULT) TIME .....	10	ALGORITHM.....	28
MAIN TIME.....	10	CONSERVATIVE FACTOR (CF).....	28
WATCH GROUP .....	10	DEEP STOP (DS).....	28
WATCH ALTS.....	10	SAFETY STOP (SS) .....	29
SHOW DUAL TIME.....	11	DIVE TIME REMAINING (DTR) .....	29
WATCH CDT (COUNTDOWN TIMER) .....	11	NDC (No Deco DTR) .....	29
CHRONOGRAPH.....	12	OTR (O2 Dive Time Remaining) .....	29
DAILY ALARM .....	12	ATR (Air Time Remaining) .....	29
SET T GROUP (TIME) .....	13	NORM DIVE MODES .....	30
Set Date Format .....	13	NO DECO MAIN AND ALTS .....	31
Set Hour Format .....	13	DEEP STOP (DS).....	31
Select Default Time .....	13	SAFETY STOP (SS) .....	31
Set Dual Time Differential .....	13	DECOMPRESSION .....	32
Set Time of Day.....	14	CV (CONDITIONAL VIOLATION).....	33
Set Date .....	14	DV 1 (DELAYED VIOLATION 1).....	33
DIVE COMPUTER OPERATING MODES .....	14	DV 2 (DELAYED VIOLATION 2).....	33
NORM SURFACE MODES .....	15	DV 3 (DELAYED VIOLATION 3).....	33
NORM SURF MAIN.....	16	VGM (VIOLATION GAUGE MODE).....	34
NORM SURF GROUP.....	16	HIGH PO2 .....	34
NORM SURF ALTS.....	16	HIGH O2.....	35
TIME TO FLY (NORM/GAUG) .....	17	GAS/TMT SWITCHING.....	36
DSAT TIME (NORM only).....	17	SWITCH ROUTINE OVERVIEW.....	37
PLAN MODE (NORM only).....	17	NORM GAS/TMT SWITCHING.....	37
LOG MODE (NORM/GAUG).....	18	GAUG TMT SWITCHING.....	37
SET F GROUP (FO2, NORM only) .....	19	GAUG OP MODE.....	38
Set FO2 Gas 1 (2, 3).....	19	GAUG SURF MAIN.....	39
Set FO2 50% Default .....	19	GAUG SURF GROUP.....	39
SET A GROUP (ALARMS, NORM/GAUG) .....	20	GAUG SURF ALTS.....	39
Set Audible Alarm.....	20	GAUG RUN TIMER.....	39
Set Depth Alarm.....	20	GAUG DIVE MAIN AND ALT .....	40
Set EDT Alarm.....	20	DV 3 (DELAYED VIOLATION 3).....	40
Set TLBG Alarm .....	20	FREE DIVE OP MODE.....	41
Set DTR Alarm .....	20	FREE SURF MAIN .....	42
Set Turn (pressure) Alarm .....	20	FREE SURF GROUP .....	42
Set End (pressure) Alarm .....	21	FREE SURF ALTS .....	42
Set PO2 Alarm.....	21	FREE CDT (Countdown Timer).....	42
SET U GROUP (UTILITIES) .....	21	FREE SET FA MENU (Free Alarms).....	43
Set Wet Activation .....	21	EDT (Elapsed Dive Time) Alarm .....	43
Set Units.....	21	DA (Depth Alarms).....	43
Set DS (NORM Deep Stop).....	21	Show NDC Time.....	44
Set SS (NORM Safety Stop).....	22	FREE DIVE MAIN AND ALT .....	44
Set Algorithm (NORM only) .....	22	FREE DIVE ALARMS .....	45
Set CF (Conservative Factor, NORM only).....	22		
Set GLO (Backlight Duration).....	22		
Set SR (Sampling Rate) .....	22		
Set TMT 1 (2, 3).....	23		

## CONTENTS (continued)

REFERENCE .....	46
PC INTERFACE .....	47
CARE AND CLEANING .....	47
INSPECTIONS AND SERVICE .....	47
BATTERY REPLACEMENT .....	48
ALTITUDE SENSING AND ADJUSTMENT .....	49
ADDITIONAL INFORMATION PERTAINING TO FREE MODE .....	49
TECHNICAL DATA .....	50
PZ+ ALGORITHM NDL CHART .....	51
DSAT ALGORITHM NDL CHART .....	51
SPECIFICATIONS .....	52
FCC COMPLIANCE .....	53
INSPECTION/SERVICE RECORD .....	54
OCEANIC WORLD WIDE .....	54

## NOTICES

**LIMITED TWO-YEAR WARRANTY**

For details, refer to the Product Warranty Registration Card provided. Register on line at [www.OceanicWorldwide.com](http://www.OceanicWorldwide.com)

**COPYRIGHT NOTICE**

This operating manual is copyrighted, all rights are reserved. It may not, in whole or in part, be copied, photocopied, reproduced, translated, or reduced to any electronic medium or machine readable form without prior consent in writing from Oceanic/2002 Design.

ATOM 3.0 Operating Manual, Doc. No. 12-5216  
© 2002 Design, 2011  
San Leandro, CA USA 94577

**TRADEMARK, TRADE NAME, AND SERVICE MARK NOTICE**

Oceanic, the Oceanic logo type, ATOM 3.0, the ATOM 3.0 logo, Air Time Remaining (ATR), Diver Replaceable Batteries, Graphic Diver Interface, Tissue Loading Bar Graph (TLBG), Pre Dive Planning Sequence (PDPS), Set Point, Control Console, Turn Gas Alarm, OceanLog, and Dual Algorithm are all registered and unregistered trademarks, trade names, and service marks of Oceanic. All rights are reserved.

**PATENT NOTICE**

U.S. Patents have been issued, or applied for, to protect the following design features:

Dive Computer with Free Dive Mode and/or Wireless Data Transmission (U.S. Patent no. 7,797,124), Air Time Remaining (U.S. Patent no. 4,586,136 and 6,543,444) and Data Sensing and Processing Device (U.S. Patent no. 4,882,678). Other patents pending. User Settable Display (U.S. Patent no. 5,845,235) is owned by Suunto Oy (Finland).

**DECOMPRESSION MODEL**

The programs within the ATOM 3.0 simulate the absorption of nitrogen into the body by using a mathematical model. This model is merely a way to apply a limited set of data to a large range of experiences. The ATOM 3.0 dive computer model is based upon the latest research and experiments in decompression theory. **Still, using the ATOM 3.0, just as using the U.S. Navy (or other) No Decompression Tables, is no guarantee of avoiding decompression sickness, i.e. "the bends."** Every diver's physiology is different, and can even vary from day to day. No machine can predict how your body will react to a particular dive profile.

**Welcome**  
**to**  
**OCEANIC**  
**and**  
**THANK YOU**  
**for choosing the**  
**ATOM 3.0**

# **FEATURES/FUNCTIONS**

# **AND**

# **WATCH MODE**

**DISPLAY ICONS**

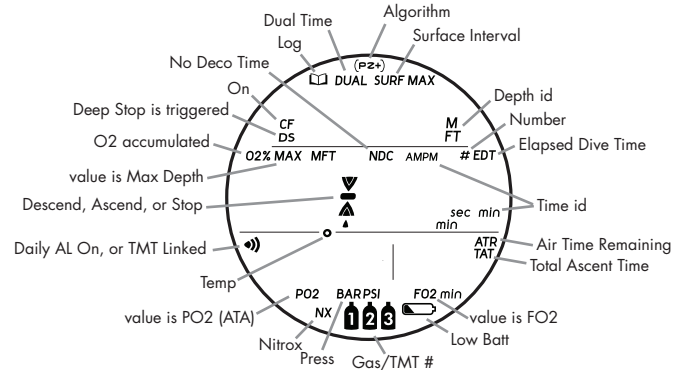

**ABBREVIATIONS/TERMS**

AL (A)	= Alarm	M	= Meters (depth)
ALGO	= Algorithm	M - D	= Month - Day
ALT	= Alternate	MAX	= Maximum
ATA	= Atmospheres Absolute (PO2)	MIN (min)	= Minutes
ATR	= Air Time Remaining	MPM	= Meters Per Minute (ascent rate)
AUD	= Audible	NDC	= No Deco Dive Time Remaining
AVAIL	= Available	NDL	= No Deco Limit
BAR	= Pressure (metric)	NOR	= Normal Dive Operating Mode
BATT (bAt)	= Battery	NX	= Nitrox
C	= Temperature (Metric)	O2%	= Oxygen (accumulated)
CDT	= Countdown Timer	OP	= Operating (mode)
CHG	= Change	OTL	= O2 Time Limit
CHRO	= Chronograph	OTR	= O2 Time Remaining
CF	= Conservative Factor	PDPS	= Pre Dive Planning Sequence
CV	= Conditional Violation	PO2	= Partial Pressure of O2 (ATA)
D - M	= Day - Month	PREV	= Preview
DA	= Depth Alarm	PSI	= Pressure (Imperial)
DECO	= Decompression	PZ+	= Algorithm (Pelagic Z+)
DFLT (dFLt)	= Default	RTMR (rt)	= Run Timer
DIFF (diFF)	= Differential	REV	= Revision (firmware)
DS	= Deep Stop	SAFE	= Safety (stop)
DSAT	= Algorithm, or Desaturate	SAT	= Time to Desaturate
DTR	= Dive Time Remaining	SEC (sec)	= Seconds
DUAL	= Time (at travel location)	SEL	= Select
DV	= Delayed Violation	SN	= Serial Number
EDT	= Elapsed Dive Time	SS	= Safety Stop
EL	= Elevation (altitude)	SR	= Sampling Rate
F	= Temperature (Imperial)	St	= Stop
FA	= Free Alarm	SURF	= Surface
FO2 (F)	= Fraction of Oxygen (%)	SWCH	= Switch (gas)
FPM	= Feet Per Minute (ascent rate)	FA	= Free Alarm
FRE	= Free Dive Operating Mode	T (t)	= Time
FT	= Feet (depth)	TAT	= Total Ascent Time (deco)
GAU	= Digital Gauge Dive Operating Mode	TLBG	= Tissue Loading Bar Graph
GLO	= Glow (backlight)	TMR	= Timer
Goto	= Access (Lead-in)	TMT	= Transmitter
HR (Hr)	= Hour	VARI	= Variable Ascent Rate Indicator
HIST	= History	VGM	= Violation Gauge Mode
LAST	= Last Dive's Data	VIOL (VIO)	= Violation

**OVERVIEW**

The ATOM 3.0 is a unique Watch/Dive Computer featuring >>

- 4 Control Buttons
- 10+ Selection Groups
- 34+ Set Selections
- Increase/Decrease Set Values
- 4 Operating Modes
- 3 Nitrox Gas Mixes
- 28+ Warnings/Alarms
- Dual Watch Time
- Dual Algorithm
- No Deco Deep Stop
- No Deco Safety Stop
- Gas/TMT Switching
- Gauge Depths to 400 FT/120 M
- Gauge Dive Run Timer
- Altitude Compensation
- NDL Conservative Factor
- Variable Ascent Rate
- PC Settings Upload/Data Download
- Audible Alarm with flashing LED
- User Replaceable Battery
- User Upgradable Firmware

**INTERACTIVE CONTROL CONSOLE**

The Interactive Control Console utilizes 4 control buttons that allow you to maneuver through the unique system of displays.

The buttons will be referred to as M, S, A, and L.

- Upper/Left >> M (mode, minus, back)
- Upper/Right >> S (select, save)
- Lower/Left >> A (advance, access, forward)
- Lower/Right >> L (light)

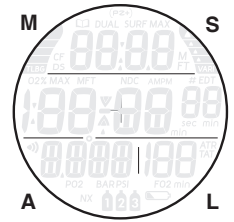

**SELECTION GROUPS**

The LCD viewing area is used to display alpha numeric messages and measured values as well as selection groups for settings and various auxiliary functions.

Selection groups include the -

- Watch Mode selections.
- Set Time selections.
- NORM Surface Mode selections.
- GAUG Surface Mode selections.
- FREE Surface Mode selections.
- Set NORM FO2 selections.
- Set NORM/GAUG Alarm selections.
- Dive Computer Operating Mode selections.
- Set Utility selections.
- Set FREE Alarm selections.

Upon entering a group, movement through it continues forward in steps or a scrolling manner, or back in steps, showing one selection screen at a time.

- The sample at the left shows how a group would look if all of the selections could be displayed at one time.

GAUG SURF SELECTIONS
SURF MAIN
SURF ALT 1
SURF ALT 2
FLY
LOG
RUN TIMER
SET A
SET U
DIVE OP MODE
HISTORY
SN
BATT/TMT

Sample Group  
(all selections shown)

**Button action >>**

- A (< 2 sec) - to access, then step forward through selection screens.
- A (hold) - to access and scroll forward through selection screens.
- M (< 2 sec) - to step back through selection screens.
- M (2 sec) - at any time, to revert to the Main.
- S (< 2 sec) - to access a selection's function screens.

**BACKLIGHT**

To activate the Backlight at any time >> press the L button (lower/right).

- The Backlight will activate and illuminate the display for button depression time\* plus the duration time set (0, 5, or 10 seconds), for a maximum of 20 seconds.

*\*The Backlight will turn Off if L is kept depressed for more than 10 seconds.*

- Press L again to activate as desired.

**Extensive use of the Backlight reduces estimated battery life. Also, the Backlight does not operate during a low battery condition or when the unit is connected to a PC.**

**AUDIBLE ALARM**

While operating in NORM or GAUG Mode, the Audible will emit 1 beep per second for 10 seconds when alarms strike, unless it is set Off. During that time, the audible can be acknowledged and silenced by pressing the S button (< 2 sec).

An LED warning light on the housing is synchronized with the audible and flashes as the Audible sounds. It will turn Off when the alarm is silenced. The audible and light will not be active if the audible is set Off (a group A setting).

FREE dive mode has its own set of alarms which emit 3 short beeps either 1 or 3 times which cannot be acknowledged or set Off.

Situations that will activate the NORM/GAUG 10 second Alarm include -

*\*\* Items apply only to NORM mode.*

- Air Time Remaining (ATR) at 5 minutes, then again at 0 minutes.
- Turn Pressure at the Set Point selected (Transmitter 1 only).
- End Pressure at the Set Point selected (active Transmitter).
- Descent deeper than the Depth Alarm Set Point selected.
- Dive Time Remaining at the Set Point selected\*\*.
- Elapsed Dive Time at the Set Point selected.
- PO2 at the Set Point selected\*\*.
- High O2 of 300 OTU (100%)\*\*.
- TLBG at the Set Point selected\*\*.
- Ascent Rate exceeds 60 FPM (18 MPM) when deeper than 60 FT (18 M), or 30 FPM (9 MPM) at 60 FT (18 M) and shallower.
- Loss of the active Transmitter Link signal for more than 15 seconds during a dive.
- Entry into Decompression Mode (Deco)\*\*.
- Conditional Violation (above a required Deco Stop Depth for less than 5 minutes)\*\*.
- Delayed Violation (above a required Deco Stop Depth for more than 5 minutes)\*\*.
- Delayed Violation (a Deco Stop Depth greater than 60 FT/18 M is required)\*\*.
- Delayed Violation (Max Operating Depth of 330 FT/100 M is exceeded).
- A Gas Switch would expose the diver to PO2 => 1.60 ATA\*\*.
- Watch Daily Alarm reaches time set (disabled during Dive Modes).
- Watch Mode Countdown Timer reaches 0:00.

A single short beep (which cannot be disabled) sounds -

- After 5 minutes on the surface after the Violation dive.

3 short beeps (which cannot be disabled) sound when -

- Ascent Rate is 51 to 60 FPM (15.1 to 18 MPM) when deeper than 60 FT (18 M), or 26 to 30 FPM (7.5 to 9 MPM) at 60 FT (18 M) and shallower.
- FREE Dive Elapsed Dive Time Alarm (3 beeps every 30 seconds if set On).
- FREE Dive Depth Alarms 1, 2, 3 (set sequentially deeper) - each 3 beeps 3 times.
- FREE Dive TLBG Alarm (Caution zone, 4 segments) - 3 beeps 3 times.
- Entry into Deco during a FREE Dive (Violation) - 3 beeps 3 times.
- Free Dive Mode Countdown Timer reaches 0:00 - 3 beeps 3 times.

During the following NORM Dive situations, the 10 second continuous tone will be followed by a 5 second beep that will not turn off when acknowledged -

- Ascent above a Deco Stop for more than 5 minutes.
- Deco requires a Stop Depth of 70 FT/21 M or deeper.
- On the Surface for 5 minutes after a Conditional Violation.

**PC INTERFACE**

Interface with a PC, to allow uploading settings and downloading data, is accomplished by connecting the unit to a PC USB port using the special USB interface cable.

The software program together with the USB driver required is on the Oceanlog CD, and can be downloaded from the OceanicWorldwide web site. The program's HELP\*\* serves as the user manual which can be printed for personal use.

*\*\*Prior to attempting to download data from your unit or upload settings to it, review the HELP section of the Oceanlog program. Recommended is to print those sections of HELP that you consider appropriate for your Interface activities.*

The settings upload portion of the Oceanlog program can be used to set/change the Main Time, Date, Set A group (Alarms), Set U group (Utilities), and FREE mode items using the same interface system. FO2 must be set using the control buttons.

Information available for retrieval (download) from the unit to the PC download portion of the program includes dive data such as number, surface interval time, maximum depth, elapsed dive time, no deco status, start date/time, lowest temperature under water, sampling rate, dive profile, and set points.

The Oceanlog program also allows upgrade of select versions of the firmware (operating system software) after which the unit resets all operating data. Since the upgrades require reset of the unit, they are blocked during 24 hours after dives.

- Refer to page 47 for more details relating to Oceanlog and PC Interface.



**POWER SUPPLY**

- Watch Battery >> (1) 3 vdc, CR2430, Lithium battery.
- Shelf life >> up to 7 years (when shipped from factory in Deep Sleep mode).
- Use life >> 1 year or 300 dive hours if (2) 1 hour dives per dive day.
- TMT (Transmitter) Battery >> (1) 3 vdc, CR2, .75 Ahr, Lithium battery.
- Use life >> 300 dive hours if (2) 1 hour dives per dive day.
- Replacement >> user replaceable (annual recommended).

**Battery icon** (applies to ATOM 3.0 only, not TMTs):

- Warning >> icon on solid < 2.75 volts, battery change recommended.
- Alarm >> icon on flashing < 2.50 volts, change the battery.

**BATTERY STATUS** (Fig. 1)

To access, while viewing NORM (or GAUG) SURF Main >>

- M (< 2 sec) to access Menu.
- A (< 2 sec), repeat until the BATT/TMT Lead-in screen. appears displaying the graphics Goto bAtt TMT (A).
- S (< 2 sec), while viewing the Goto, activates Receiver, then ATOM Status screen appears for 3 sec (B), then each active TMT's Status screen for 3 sec (C).

**ATOM 3.0 LOW BATTERY WHILE ON THE SURFACE**

<= 2.75 volts (warning level)

- Backlight is completely disabled.
- Battery icon (shell with inner bar) appears solid on the Watch and DC Surface Main screens (Fig. 2a).
- If a dive is started, the icon is not displayed on the dive mode screens.
- Watch and DC functions continue to be available.

<=2.50 volts (Too Low - alarm level)

- All operations as a DC (dive computer) are terminated and the unit operates only as a Watch.
- Low Battery icon (shell only with no inner bar) flashes for 5 seconds and operation reverts to Watch Time (Fig. 3) until the Battery is changed or voltage cannot sustain operation (< 2.35 volts) and the unit turns off.

**ATOM 3.0 LOW BATTERY DURING A DIVE**

<= 2.75 volts (warning level)

- Backlight is completely disabled.
- Full DC functions continue to be available.
- Battery icon is not displayed on the dive mode screens.
- Battery icon (shell with inner bar) appears solid upon entry into Surface Mode.

<= 2.50 volts (Too Low - alarm level)

- Backlight is completely disabled.
- Full DC functions continue to be available during the dive.
- Battery icon is not displayed on the dive mode screens.
- Upon entry into Surface Mode, the Battery icon (shell only with no inner bar) flashes for 5 seconds during which the graphics CHG and bAt alternate (Fig. 4) and operation reverts to Watch Time (page 18) until the Battery is changed or voltage cannot sustain operation (< 2.35 volts) and the unit turns off.

**TMT (TRANSMITTER) LOW BATTERY**

Indication is only provided while on the surface.

<= 2.75 volts (warning level)

- The graphics bAtt, LOW, and TMTx with icon appear solid on the Battery Status screen (Fig. 5).
- DC functions continue to be available (surface and dive).

<= 2.50 volts (Too Low - alarm level)

- The graphic TMT1 alternates with the graphic BATT LO in place of Pressure on the NORM (or GAUG) SURF Main screen (Fig. 6).
- The graphics bAtt, LOW, and TMTx with icon also flash on the Battery Status screen.
- TMT operation continues until Tank Pressure decreases to 50 PSI.

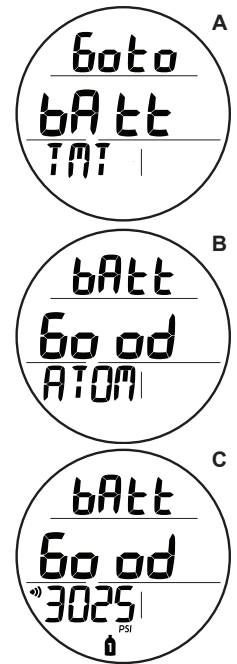

Fig. 1 - BATTERY STATUS

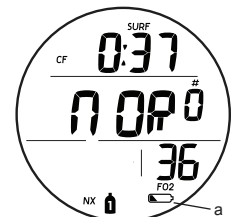

Fig. 2 - SURF MAIN (low battery warning)

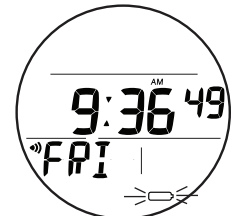

Fig. 3 - WATCH MAIN (low battery alarm)

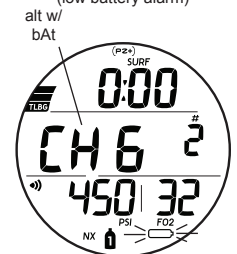

Fig. 4 - SURF MAIN (low battery alarm during dive)



Fig. 5 - TMT BATT STATUS (low battery warning)



Fig. 6 - SURF MAIN (TMT low battery alarm)

**WATCH MAIN (DEFAULT) TIME**

Selection of Main (Default) Time is a Set T menu item.

Time of day and date can be set when either Home or Away time is selected as the default.

Main Time is the current time at your home location and is normally selected as the Watch Default Time.

Away Time, set by Hour Differential, is the current Time at a remote travel location. Upon arrival at the location, Away Time can be interchanged with Main Time to make it the Default Time while visiting the travel location.

Dual Time is the second, or differential time, that can be displayed simultaneously with Main Time when enabled. It is a +/- Hour Differential based on the Time that is set while at home or the opposite if set while away.

Once Dual Time (the Hour differential) is set, it will automatically change when Time of Day is changed. When Away Time is selected to be the Watch Default Time (while at a travel location), it will be changed directly when Time of Day is changed and Home Time will then change by a Hour differential opposite the one set for Dual Time.

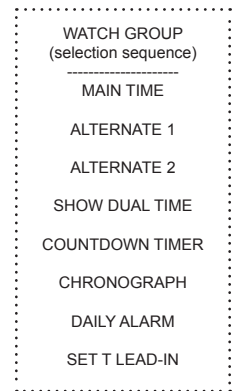

Fig. 7 - WATCH MAIN (Home, Dual on)

**MAIN (Default) TIME**, information includes (Fig. 7):

- > Dual Time (hr:min) with icon, if enabled.
- > Main (Default) Time (hr:min\_sec) with AM (or PM) icon.
- > Alarm (speaker) icon, if Daily Alarm is set On.
- > Day of Week graphic (MON, TUE, etc.).
- > Away Time icon (lazy 8), meaning Away is selected as Main Time, blank if Home is Main.
- > Battery icon, if a Low Battery voltage exists.
- > TLBG with icon, if any after NORM or FREE dives.

- M (2 sec) - to access NORM Surface Main.
- A (< 2 sec) - to access Watch ALT 1.
- M (< 2 sec) - to access Set T (Time/Date).
- S (< 2 sec) - to silence the Daily Alarm.
- L (press) - to activate the Backlight.



**WATCH GROUP**, button operations\* >>

*These operations apply to all group selections that follow, those marked with \* are not repeated when describing each selection.*

- A (< 2 sec) - to step forward through selections.
- A (hold)\* - to scroll forward through selections.
- M (< 2 sec) - to step back through selections.
- M (2 sec, any time)\* - revert to Main.
- No button action (2 min)\* - revert to Main.
- L (press)\* - to activate the Backlight.

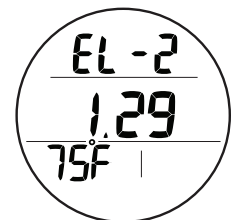

Fig. 8 - WATCH ALT 1

**WATCH ALT 1**, information includes (Fig. 8):

- > Altitude graphic EL - 2 to EL - 7, blank if Sea level.
- > Date, as Month.Day (or Day.Month).
- > Temperature with ° icon and graphic F (or C).

- A < 2 sec - to step forward to ALT 2 (if Dual Time is not on Main), or bypass ALT 2 to Show Dual Time Lead-in (if Dual Time is on Main).
- M < 2 sec - to step back to Watch Main.

**WATCH ALT 2**, information includes (Fig. 9):

*This selection is bypassed if Dual Time is displayed on Main.*

- > Dual Time (hr:min) with icon.
- > Graphic AWAY (or HOME), indicating the location that Dual applies to.

- A < 2 sec - to step forward to Show Dual Time Lead-in.
- M < 2 sec - to step back to ALT 1.



Fig. 9 - WATCH ALT 2 (only if set & not on Main)

**SHOW DUAL TIME**

This selection allows Dual Time, which is set by an hour differential, to be added, or removed from, to the Watch Main screen.

**Dual Time Lead-in**, information includes (Fig. 10):

- > Graphics Goto, SHOW, and DUAL.
- S (< 2 sec) - to access Show Dual Time.
- A (< 2 sec) - to step forward to CDT Lead-in.
- M (< 2 sec) - to step back to Watch ALT.

**Show Dual Time**, information includes (Fig. 11):

- > Graphic YES (or NO) flashing, or 2 dashes ( - - ) if no differential is set.
- > Graphics SHOW and DUAL with icon.
- A or M (< 2 sec) - to toggle between YES and NO.
- S (< 2 sec) - to save the setting and revert to Lead-in.
- S (2 sec) - to step back to Lead-in, if no setting change.

**WATCH CDT (Countdown Timer)**

This selection provides access to a CDT for use in Watch mode.

Upon accessing a dive computer mode, Watch CDT operation will be terminated and the time reset to the previous setting.

**CDT Lead-in**, information includes (Fig. 12):

- > Graphics Goto and CDT.
- S (< 2 sec) - to access CDT Status.
- A (< 2 sec) - to step forward to Chrono Lead-in.
- M (< 2 sec) - to step back to Dual Time Lead-in.

**CDT Status**, information includes (Fig. 13):

- > Graphic OFF (or ON) flashing. If OFF, 0:00 or the CDT if previously set. If ON, the remaining CDT (hr:min).
- > Graphic CDT.
- A (< 2 sec) - to step forward through selections of OFF, ON, and SET.
- M (< 2 sec) - to step back through selections.
- S (< 2 sec) - to save the selection.
  - >> If OFF or ON is selected, revert to the Lead-in screen.
  - >> If SET is selected, access the Set CDT screen.
- S (2 sec) - to revert to CDT Lead-in, if no setting change.

**Set CDT**, information includes (Fig. 14):

- > Graphics SEt and CDT.
- > Timer setting (hr:min), with Hour digits flashing.
- A (hold) - to scroll upward through Hour Set Points (8/sec) from 0: to 23: in increments of 1: (hr).
- A (< 2 sec) - to step upward through Hour Set Points.
- M (< 2 sec) - to step back through Set Points.
- S (< 2 sec) - to save the Hour setting and flash the Minute digits.
- A (hold) - to scroll upward through Minute Set Points (8/sec) from :00 to :59 in increments of :01 (min).
- A (< 2 sec) - to step upward through Minute Set Points.
- M (< 2 sec) - to step back through Set Points one at a time.
- S (< 2 sec) - to save the CDT setting and revert to the CDT Status screen with the graphic SEt flashing (Fig. 15).
- > ON will then start the countdown and revert to CDT Lead-in.
- > OFF will save the setting and revert to CDT Lead-in.

The CDT will run in the background until it counts down to 0:00, or it is set OFF, or DC Mode is accessed or a Dive is started in which case the countdown will terminate and revert to OFF.

When a set CDT reaches 0:00, the Audible will sound during which time the graphic CDT will flash on the Watch Main.



Fig. 10 - DUAL TIME LEAD - IN (to access Show)



Fig. 11 - SHOW DUAL TIME (to add to Main)

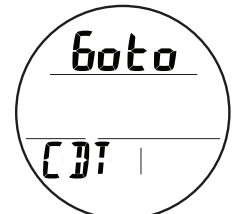

Fig. 12 - CDT LEAD - IN (to access CDT Status)



Fig. 13 - CDT STATUS



Fig. 14 - SET CDT (after access from Status)



Fig. 15 - CDT STATUS (after being set)

**CHRONOGRAPH**

The Chronograph is a stop watch timer for use in Watch mode.

While the Chronograph is running, it remains on the screen until another screen is accessed, it will then continue to run in the background while on the surface until stopped and reset.

When a dive is started (descent to 5 FT/1.5 M), Chrono operation will be terminated and the time will reset to 0:00\_00.

**Chrono Lead-in**, information includes (Fig. 16):

> Graphics Goto and CHRO.

- S (< 2 sec) - to access Chrono Status.
- A (< 2 sec) - to step forward to Daily Alarm Lead-in.
- M (< 2 sec) - to step back to CDT Lead-in.

**Chrono Status**, information includes (Fig. 17):

> Graphics LAP1 (or 2 to 9) and CHRO.  
 > Elapsed run time counting up (if previously started), or 0:00\_00 (min:sec\_1/100th sec), flashing.

- S (< 2 sec) - to start the Timer which begins counting up to 1:59:59\_99 max in increments of .01 sec.

*After the first 4.99 seconds, the .01 digits display 2 dashes.*

- S (< 2 sec) - to save that Lap's time and display the next Lap # (up to 9, then restart with 1) with the Timer continuing to count up, displaying total run time.
- A (< 2 sec) - to stop the Timer and recall LAP1 flashing with it's time (Fig. 18). *Repeat to recall other Lap times.*
- A (2 sec) - to reset total run time to 0:00\_00.
- S (2 sec) - to exit and revert to the Chrono Lead-in.

**DAILY ALARM**

When set On, the Daily Alarm will -

- > be synchronized with the Watch Default Time selected.
- > sound the Audible at the Time set every day.
- > not sound the Audible while operating in DC Modes.
- > run in the background until set Off.

**Daily Alarm Lead-in**, information includes (Fig. 19):

> Graphics Go to and DAY AL.

- S (< 2 sec) - to access Daily Alarm Status.
- A (< 2 sec) - to step forward to Set T Lead-in.
- M (< 2 sec) - to step back to Chrono Lead-in.

**Daily Alarm Status**, information includes (Fig. 20):

> Set Point graphic ON (or OFF) flashing.  
 > Alarm Time (hr:min) with AM (or PM) icon if 12 Hour.  
 > Graphics DAY AL.

- A (< 2 sec) - to step forward through the selections of OFF, ON, and SET.
- M (< 2 sec) - to step back through the selections.
- S (< 2 sec) - to save the selection, and -  
 > if OFF or ON is selected, revert to Daily Alarm Lead-in.  
 > if SET is selected, the Set screen is accessed.

**Set Daily Alarm**, information includes (Fig. 21):

> Graphics SET and DAY AL.  
 > Alarm Time (hr:min) with icon, Hour digits flashing.

- A (hold) - to scroll upward through Hour Set Points (8/sec) from 0: to 23: in increments of 1: (hr).
- A (< 2 sec) - to step upward through Hour Set Points.
- M (< 2 sec) - to step back through Set Points.
- S (< 2 sec) - to save the Hour setting and flash the Minute digits.
- A (hold) - to scroll upward through Minute Set Points (8/sec) from :00 to :59 in increments of :01 (min).
- A (< 2 sec) - to step upward through Minute Set Points.
- M (< 2 sec) - to step back through Set Points.
- S (< 2 sec) - to save the Alarm setting and revert to the Daily Alarm Status screen with SET flashing (Fig. 22).

To turn the alarm function On -

- A or M (< 2 sec) - to step through the selections (OFF, ON, SET) to ON.
- S (< 2 sec) - to save the ON selection (enable the alarm) and revert to the Set Daily Alarm Lead-in.

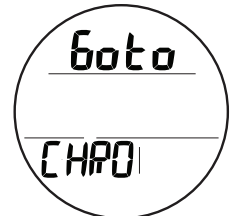

Fig. 16 - CHRONO LEAD-IN



Fig. 17 - CHRONO STATUS (Lap 1 started, counting up)



Fig. 18 - CHRONO LAP RECALL

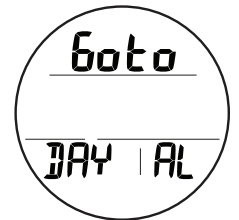

Fig. 19 - DAILY ALARM LEAD-IN



Fig. 20 - DAILY ALARM STATUS (to access Set)

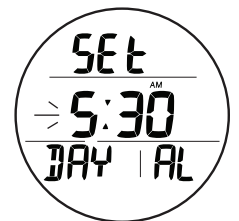

Fig. 21 - SET DAILY ALARM



Fig. 22 - DAILY ALARM STATUS (Set, ready)

**SET T GROUP (TIME)**

Sequence >> Lead-in >> Date Format >> Hour Format >> Default Time >> Dual Time >> Time of Day >> Date.

Set Points remain as set until changed.

**Set T Lead-in**, information includes (Fig. 23):

> Graphics Goto and SET t.

- S (< 2 sec) - to access Set Date Format.
- A (< 2 sec) - to step forward to Watch Main Time.
- M (< 2 sec) - to step back to Daily Alarm Lead-in.

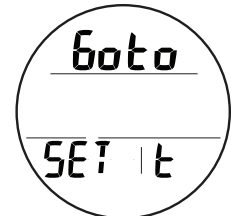

Fig. 23 - SET T LEAD-IN

**Set Date Format**, information includes (Fig. 24):

Date Format establishes the position that the Month (M) digits are displayed relative to the Day (D) digits, on the left or right.

> Graphic SEt.  
> Set Point graphic M - D (or D - M) flashing.

- A or M (< 2 sec) - to toggle the Set Points.
- S (< 2 sec) - to save setting and access Set Hour Format.
- S (2 sec) - to step back to Set T Lead-in.

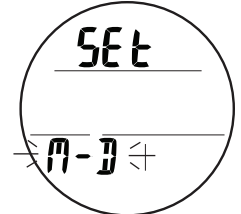

Fig. 24 - SET DATE FORMAT

**Set Hour Format**, information includes (Fig. 25):

Hour Format establishes number of hours displayed for Time of Day, 1 to 12 (AM and PM) or 1 to 24.

> Graphics SEt and Hr.  
> Set Point graphic 12 (or 24) flashing.

- A or M (< 2 sec) - to toggle the Set Points.
- S (< 2 sec) - to save setting and access Set Default Time.
- S (2 sec) - to step back to Set Date Format.

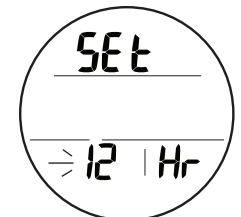

Fig. 25 - SET HOUR FORMAT

**Select Default Time**, information includes (Fig. 26):

This feature selects which Time, Home or Away, is to be displayed as the Watch Main (Default) Time (in the center of the Watch Time screen)\*.

\*The other will be displayed (at the top of the Watch Time screen) when a Dual Time (differential) is set and Show Dual Time is set for YES.

> Graphics SEL and dFLt.  
> Set Point graphic HOME (or AWAY) flashing.

- A or M (< 2 sec) - to toggle the Set Points.
- S (< 2 sec) - to save setting and access Set Dual Time Diff.
- S (2 sec) - to revert to Set Hour Format.

HOME is the time where you live, work, spend most of your time.  
AWAY is the time set for a travel destination.

DEFAULT is the time you choose as the Watch's local main time (Home or Away).  
DUAL is the time at the other remote location (Away or Home).



Fig. 26 - SELECT DEFAULT  
(as Watch Main Time)

**Set Dual Time Differential**, information includes (Fig. 27):

This feature allows you to set an Hour based numeric time Differential ranging from - 23 through 0 to + 23 (hours).

It provides a second (Dual) Time equal to the Watch's Default Time of Day +/- the Hours selected.

> Graphics SEt, diFF, and Hr, with DUAL icon.  
> Set Point graphic OFF, or the Hour Differential numeric digits with + (or -) icon, flashing.  
> Lazy 8 icon (Fig. 28a) meaning Away is the Watch Main (default) Time, no icon if Home is the default.

- A (hold) - to scroll upward through the Set Points (8/sec) from - 23 through 0 to + 23 in increments of 1 (hour).
- A (< 2 sec) - to step upward through Set Points.
- M (< 2 sec) - to step back through Set Points.
- S (< 2 sec) - to save the setting and access Set Time.



Fig. 27 - SET DUAL TIME  
(when Home is default)



Fig. 28 - SET DUAL TIME  
(when Away is default)

**Set Time of Day**, information includes (Fig. 29):

This setting directly changes the Time of Day, whichever one is selected as the Default, Home Time or Away.

The other will be changed by the Dual Time (Hour Differential) set.

- > Graphics SET and HOME (or AWAY).
- > Time of Day (hr:min), Hour digits flashing, with AM (or PM) icon if 12 Hour Format, no icon if 24 Hour.
- A (hold) - to scroll upward through Hour Set Points (8/sec) from 12: AM to 11: PM, or 0: to 23: if 24 Hour Format, in increments of 1: (hr).
- A (< 2 sec) - to step upward through Hour Set Points.
- M (< 2 sec) - to step back through Set Points.
- S (< 2 sec) - to save the Hour setting and flash the Minute digits (Fig. 30).
- S (2 sec) - to step back to Set Dual Time Differential.
- A (hold) - to scroll upward through Minute Set Points (8/sec) from :00 to :59 in increments of :01 (min).
- A (< 2 sec) - to step upward through Minute Set Points.
- M (< 2 sec) - to step back through Set Points.
- S (< 2 sec) - to save the Time setting and access Set Date.
- S (2 sec) - to step back to Set Hour.



Fig. 29 - SET TIME  
(when Home is default)



Fig. 30 - SET TIME  
(while Away is default)

**Set Date**, information includes (Fig. 31):

Sequence is Year >> Month >> Day, regardless of Format set.

- > Graphic SET.
- > Month.Day (or Day.Month) digits.
- > Year Set Point, digits flashing.
- A (hold) - to scroll upward through Year Set Points (8/sec) from 2010 to 2053, in increments of 1.
- A (< 2 sec) - to step upward through Year Set Points.
- M (< 2 sec) - to step back through Set Points.
- S (< 2 sec) - to save the Year setting and flash the Month digits.
- S (2 sec) - to step back to Set Time.
- A (hold) - to scroll upward through Month Set Points (8/sec) from 1 to 12 in increments of 1.
- A (< 2 sec) - to step upward through Set Points.
- M (< 2 sec) - to step back through Set Points.
- S (< 2 sec) - to save the Month Set Point and flash the Day digits.
- S (2 sec) - to step back to Set Year.
- A (hold) - to scroll upward through Day Set Points (8/sec) from 1 to 31 (max) in increments of 1.
- A (< 2 sec) - to step upward through Set Points.
- M (< 2 sec) - to step back through Set Points.
- S (< 2 sec) - to save the Date Set Point and revert to the Set T Lead-in.
- S (2 sec) - to step back to Set Month.

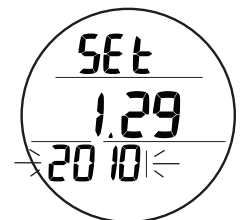

Fig. 31 - SET DATE  
(while Away)

## DIVE COMPUTER OPERATING MODES

NORM Mode >> for Air and Nitrox SCUBA activity with 1 to 3 Gases/TMTs.

GAUG Mode >> for SCUBA activity with 1 to 3 TMTs.

FREE Mode >> for breath hold diving activity with Depth/Time indication.

If no previous dive has been taken within the past 24 hours, NORM is the default upon access from Watch Mode. Others can be accessed using the Surface Menu.

At any time while operating in Surface Modes, operation will enter the Dive Mode selected upon descent to 5 FT (1.5 M) for 5 seconds.

Operation will revert from Dive Mode to Surface Mode upon ascent to 2 FT (0.6 M) for 1 second.

During the first 10 minutes after a NORM/GAUG dive, or 1 minute after a FREE dive, the Dive Main screen will remain on displaying Elapsed Dive Time and Pressure together with Surface Interval Time in place of Current Depth.

- During the first 10 minutes (or 1 minute), Dive ALT screens can be viewed and Gas/TMT Switching can be performed.
- A descent during the first 10 minutes after surfacing from a NORM or GAUG dive, or the first 1 minute after surfacing from a FREE dive, is a continuation of that dive.
- After the 10 minute (or 1 minute) interval has elapsed, the normal Surface Main will be displayed with access given to the Surface group selections. A descent is then considered a new dive.

# **NORM**

## **SURFACE MODES**

**NORM SURF MAIN**, information includes (Fig. 32):

- > (PZ+) icon, if selected as Algorithm, no icon if DSAT.
- > CF icon, if Conservative Factor is set On.
- > Surface Interval time (hr:min) with SURF icon; *if no dive yet, this is time since mode access.*
- > Graphic NOR.
- > Dive number with # icon, up to 24 for that operating period (0 if no dive made yet).
- > TMT 1 Pressure with PSI (or BAR) and link (speaker) icons, if active. *#1 is the default in Surface Mode.*
- > FO2 Set Point (21 to 100%), if FO2 is set for Nitrox.
- > NX icon, if FO2 is set for Nitrox.
- > Gas/TMT (tank) 1 icon. *#1 is the default in Surface Mode.*
- > TLBG with icon, if any after a NORM or FREE dive.
- > Battery icon, if voltage is low.

- M (2 sec) - to access Watch Main.
- A (< 2 sec) - to access NORM SURF ALT 1.
- M (< 2 sec) - to access BATT/TMT.
- L (press) - to activate the Backlight.

Upon surfacing during dives, the Dive Main will remain on display for the first 10 minutes, with Surface Interval time (SI) in place of Depth, after which the post dive Surface Main will be displayed (Fig. 33).

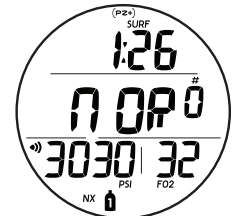

Fig. 32 - NORM SURF MAIN (no dive yet)

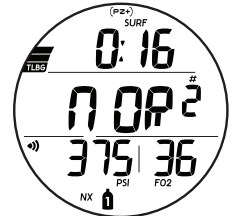

Fig. 33 - NORM SURF MAIN (> 10 min after dive 2)

**NORM SURFACE GROUP**, button operations\* >>

*These operations apply to all group selections that follow, those marked with \* are not repeated when describing each selection.*

- A (< 2 sec) - to step forward through selections.
- A (hold)\* - to scroll forward through selections.
- M (< 2 sec) - to step back through selections.
- M (2 sec, any time)\* - revert to Main.
- No button action (2 min)\* - revert to Main.
- L (press)\* - to activate the Backlight.

*Various descriptions that follow (as labeled) apply to GAUG as well as NORM.*

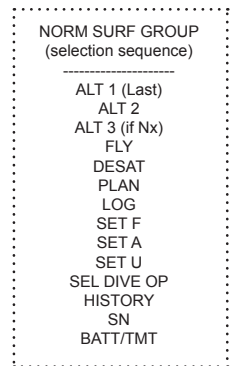

*\*Dashes if no previous dive conducted.*

**NORM SURF ALT 1**, information includes (Fig. 34):

- > SI\* (hr:min) with SURF icon, prior to Last dive.
- > Graphic LAST, indicating data is for the dive previously conducted while still in NORM mode.
- > Max Depth\* with MAX and FT (or M) icons.
- > Elapsed Dive Time\* (up to 999) with EDT and min icons.

- A (< 2 sec) - to step forward to ALT 2.
- M (< 2 sec) - to step back to Main.



Fig. 34 - NORM SURF ALT 1 (Last dive's data)

**NORM SURF ALT 2**, information includes (Fig. 35):

- > Altitude graphic (EL - 2 to EL - 7), blank if Sea level.
- > Time of Day (hr:min\_sec) with AM or PM icon if 12 Hour Format, no icon if 24 Hour Format.
- > Temperature with ° icon and graphic F (or C).

- A (< 2 sec) - to step forward to ALT 3 if Nitrox, or FLY if Air.
- M (< 2 sec) - to step back to ALT 1.



Fig. 35 - NORM SURF ALT 2

**NORM SURF ALT 3**, information includes (Fig. 36):

*This screen is bypassed if FO2 is set for Air and prior to first dives of an activation period.*

- > Current O2 saturation with O2% icon.
- > PO2 alarm value set (ATA) with PO2 icon.
- > FO2 set for Gas 1 (21 to 100%) with FO2.
- > NX and Gas (tank) 1 icons.
- > (PZ+) icon, if selected, no icon if DSAT.
- > CF icon, if set On.

- A (< 2 sec) - to step forward to FLY.
- M (< 2 sec) - to step back to ALT 2.

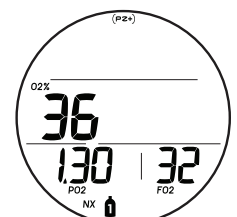

Fig. 36 - NORM SURF ALT 3 (only if Nitrox)



**TIME TO FLY (NORM/GAUG)**

Time to Fly is a countdown timer that begins counting down from 23:50 to 0:00 (hr:min) 10 minutes after surfacing from a dive (NORM, GAUG, or FREE).

**FLY**, information includes (Fig. 37):

- > Time to Fly countdown (hr:min), - : - - if no dive yet, 0:00 if time has elapsed.
- > Graphic FLY.
  
- A (< 2 sec) - to step forward to DSAT if NORM, or LOG if GAUG.
- M (< 2 sec) - to step back to ALT 3 if Nitrox, or ALT 2 if Air or GAUG.



Fig. 37 - TIME TO FLY (beginning 10 min after dives)

**DSAT TIME (NORM only)**

Time to Desaturate (Dsat Time) is also a countdown timer. It is calculated time for tissue desaturation at sea level.

Beginning 10 minutes after surfacing from a NORM or FREE dive, it counts down from a maximum of 23:50 to 0:00 (hr:min).

Dsat requiring more than 24 hours will display 24HR until it decreases to 23:59.

After a FREE dive, access to the DSAT screen can be gained by first accessing the NORM Mode.

After a violation dive, 3 dashes (- - -) will be displayed in place of countdown time.

- > When other screens are accessed, the DSAT time continues to countdown in the background.
- > In the event that time to desaturate still remains at the end of 24 hours, any remaining time will be cleared.



Fig. 38 - TIME TO DSAT

*We do not go beyond 24 hours since there is not a realistic set of repetitive dive profiles on SCUBA for which the 480 minute tissue exceeds 8 FSW, which clears at 24 hours. All other tissues with a half time of 160 minutes or less will have desaturated in less than 12 hours.*

**DSAT**, information includes (Fig. 38):

- > Time to Desaturate (hr:min), - : - - if no dive yet, 0:00 if no time remaining.
- > Graphic DSAT.
  
- A (< 2 sec) - to step forward to PLAN.
- M (< 2 sec) - to step back to FLY.

**PLAN MODE (NORM only)**

Dive time calculations in Plan Mode are based on -

- > the algorithm selected (DSAT or PZ+).
- > the FO2 value set for Gas 1, the default used for Plan.
- > the setting for the Conservative Factor (Off or On\*).
- > any residual nitrogen remaining, or oxygen accumulation, from previous dives (NORM or FREE)

*\*When the Conservative Factor is set On, Dive times are reduced to the values of the next higher 3000 foot (915 meter) Altitude. Refer to tables in back.*

**Plan Lead-in**, information includes (Fig. 39A, B):

- > (PZ+) icon if selected, no icon if DSAT.
- > Graphic PLAN.
- > CF icon, if set On.
- > Graphic AIR, or PO2 alarm value set (ATA) with PO2 and NX icons if Nitrox.
- > Gas 1 FO2 Set Point, 21 to 100 (%), with FO2 icon, if Nitrox.
- > Gas 1 (tank) icon, default for Plan.

- A (< 2 sec) - to step forward to Log.
- M (< 2 sec) - to step back to DSAT.
- S (< 2 sec) - to access PDPS.

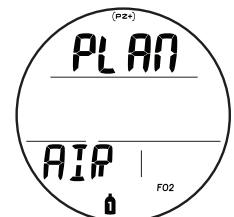

Fig. 39A - PLAN LEAD-IN (FO2 Gas 1 set for Air)

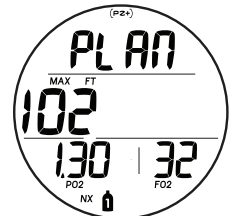

Fig. 39B - PLAN LEAD-IN (FO2 Gas 1 set for Nitrox)

**PDPS (Pre Dive Planning Sequence)**

The PDPS displays Depths and allowable Dive Times (up to 999 minutes), NDLs (No Deco limits) if nitrogen loading is in control or OTLs (O2 limits) if oxygen accumulation is in control.

PDPS screens will display Depths from 30 to 190 FT (9 to 57 M) with Plan times\* based upon the previous dive profiles in a series of repetitive dives and taking into account descent and ascent rates of 60 FPM (18 MPM).

*\*If less than 1 minute time is available, dashes will be displayed for time, and Depth values will flash.*

**PDPS**, information includes (Fig. 40A, B):

- > Plan Depth value with FT (or M) icon.
- > Dive Time allowed with NDC (or O2) and min icons.
- > Graphic AIR, or Gas 1 FO2 Nitrox Set Point (21 to 100) with FO2 icon.
- > Gas 1 (tank) icon, default for Plan.
- > NX, (PZ+), CF icons - if they apply.

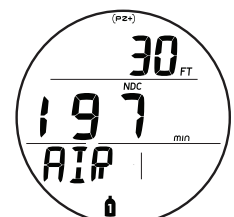

Fig. 40A - PDPS (FO2 Gas 1 set for Air)



Fig. 40B - PDPS (FO2 Gas 1 set for Nitrox)

- A (< 2 sec) - to step forward through PDPS screens.
- A (hold) - to scroll forward through PDPS screens (8/sec) from 30 to 190 FT (9 to 57 M) in increments of 10 FT (3 M).
- M (< 2 sec) - to step back through PDPS screens.
- S (< 2 sec) at any time - to exit and revert to Plan Lead-in.

**LOG MODE (NORM/GAUG)**

Information from the latest 24 NORM and/or GAUG dives is stored for viewing.

- > After exceeding 24 dives, data for the most recent dive is recorded and the oldest is deleted.
- > Dives are numbered from 1 to 24 starting each time NORM (or GAUG) Dive Mode is activated. After the post dive 24 hour period has elapsed and DC operation shuts off, the first dive of the next DC activation period will be #1.
- > In the event that a dive's elapsed time (EDT) exceeds 199 (min), the data at the 199 (min) interval is recorded in the Log upon surfacing of the unit.

Sequence >> Lead-in > Preview > Data 1 > Data 2 > Data 3.

**Log Lead-in**, information includes (Fig. 41):

- > Log (book) icon.
- > Graphics Goto and LOG.

- A (< 2 sec) - to step forward to SET F.
- M (< 2 sec) - to step back to PLAN.
- S (< 2 sec) - to access Log Preview.

**Log Preview**, information includes (Fig. 42):

- > Log Mode (book) icon.
- > Date (month.day or day.month), the dive was conducted.
- > Time dive began (hr:min) with AM (or PM) icon if 12 Hour Format, no icon if 24 Hour Format, and lazy 8 icon if Away time; or graphics NONE YET if no dive recorded.
- > Dive number (1 to 24, 0 if no dive yet) with # icon.
- > Graphic NOR (or GAU or VIO).
- > NX, (PZ+), CF, DS icons - if they apply.

- A (< 2 sec) - to step through Preview screens from the most recent to the oldest recorded.
- A (hold) - to scroll through Preview screens from the most recent to the oldest recorded (8/sec).
- M (< 2 sec) - to step back through Preview screens.
- S (< 2 sec) - to access Data 1 for the dive displayed.
- S (2 sec) at any time - to revert to Log Lead-in.

**Log Data 1**, information includes (Fig. 43A, B):

- > Log Mode (book) icon
- > Pre dive SI (hr:min), - : - if no previous dive that activation period, with SURF icon.
- > Max Depth with MAX and FT (or M) icons.
- > Elapsed Dive Time with EDT and min icons.
- > Pressure of Tank 1 at end of dive with PSI (or BAR) and TMT (tank) 1 icons.
- > Total Ascent Time (min) with TAT and min icons, if Deco.
- > TLBG with the max accumulation segment flashing, others fixed up to end of dive accumulation. All segments flashing if a Delayed Violation. No TLBG if Gauge Mode.
- > VARI, max Ascent Rate sustained for 4 sec
- > NX, (PZ+), CF, DS icons - if they apply

- S (< 2 sec) - to access Data 2 for the dive displayed.
- S (2 sec) at any time - to revert to Log Lead-in.

**Log Data 2**, information includes (Fig. 44):

- > Log Mode (book) icon.
- > Graphic SEA (or EL - 2 to EL - 7), indicating the Altitude at which the dive was conducted.
- > Temperature with ° icon and graphic F (or C), indicating the minimum recorded during that dive.

- S (< 2 sec) - to access Data 3 for that dive; or revert to Preview if a GAUG dive.
- S (2 sec) at any time - to revert to Log Lead-in.

**Log Data 3**, information includes (Fig. 45):

- > Log Mode (book) icon.
- > Graphic O2.
- > O2 saturation (%) at end of dive with O2% icon, 2 dashes if Violation Gauge Mode.
- > Highest PO2 (ATA) value reached during the dive with PO2 icon.
- > FO2 Set Point for the Gas in use when dive ended with FO2 and Gas (tank) icons.
- > NX, (PZ+) icons - if they apply.

- S (< 2 sec) - to revert to that dive's Log Preview.
- S (2 sec) at any time - to revert to Log Lead-in.

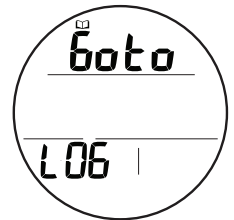

Fig. 41 - LOG LEAD-IN

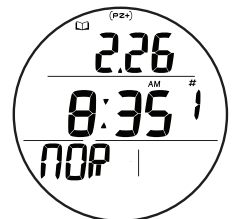

Fig. 42 - LOG PREVIEW (Deco during dive)

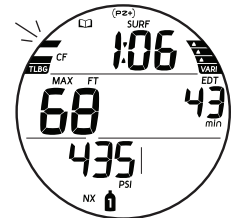

Fig. 43A - LOG DATA 1 (No Deco, Nitrox)

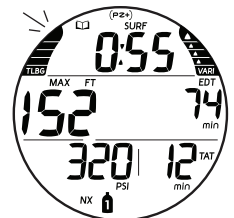

Fig. 43B - LOG DATA 1 (Deco, Nitrox)

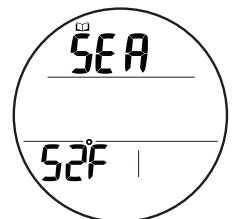

Fig. 44 - LOG DATA 2

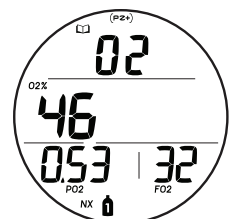

Fig. 45 - LOG DATA 3 (only if NORM Nitrox)

**SET F GROUP (FO2), NORM only**

Selections >> FO2 Gas 1 > FO2 Gas 2 > FO2 Gas 3 > FO2 50% Default.

- > FO2 settings revert to AIR 24 hours after a dive.
- > The FO2 50% Default remains as set until changed.

**FO2 50% Default:**

- > When set ON and FO2 Gas 1 is set for a numerical value, 10 minutes on the surface after that dive FO2 Gas 1 is displayed as 50% and further dives are calculated based on 50% O2 for oxygen calculations and 21% O2 for nitrogen calculations (79% Nitrogen) unless FO2 Gas 1 is set before the dive.
- > FO2 Gas 1 continues to reset to the 50% Default after subsequent repetitive dives until 24 hours elapse after the last dive, or the Default is set OFF.
- > When set OFF, FO2 Gas 1 remains at the last Set Point for that period of activation.
- > If set OFF, the FO2 for all gases remain at their respective Set Points until changed.
- > If set ON, the FO2 for all gases default to 50%.

**FO2 Gas 1 set for AIR:**

- > FO2 for Gas 1 each new dive period will be AIR, and calculations will be the same as when it is set for 21% O2.
- > It remains set for AIR until it is set for a numerical value (21 to 100%).
- > O2% and PO2 values and/or warnings are not displayed, on surface or during dive.
- > Max operating depths affected by the PO2 limit set are not displayed in Plan.
- > The unit keeps track of the O2 loading so that if FO2 Gas 1 is subsequently set for a numerical value, the O2 accumulated during previous AIR dives will be accounted for in the next Nitrox dive (during that dive period and series of repetitive dives).

**FO2 set for Nitrox:**

- > When FO2 for any Gas is set for a numerical value (21 to 100%), the dive is considered Nitrox with the NX icon displayed on all applicable screens.
- > Once FO2 for Gas 1 is set for a numerical value (21 to 100%), the AIR option for all gases is disabled until 24 hours elapse after the last dive.
- > The AIR option is not be displayed in Set FO2 until a full 24 hour Surface Interval has elapsed.

**Set F Lead-in**, information includes (Fig. 46):

- > Graphics Goto and SET F.

- A (< 2 sec) - to step forward to SET A.
- M (< 2 sec) - to step back to LOG.
- S (< 2 sec) - to access Set FO2 Gas 1.

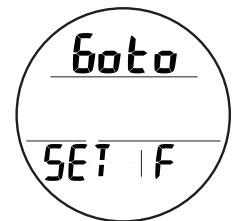

Fig. 46 - SET F LEAD-IN

**Set FO2 Gas 1** (2, 3 similar), information includes (Fig. 47):

- > Graphic SET.
- > Graphic AIR flashing (Fig. 47A), with Gas (tank) 1 (or 2 or 3) and FO2 icons.

-- or --

- > Max Depth allowed with MAX and FT (or M) icons.
- > PO2 Alarm value set (ATA) with PO2 icon.
- > FO2 value flashing (Fig. 47B), with NX, Gas (tank) 1 (or 2 or 3) and FO2 icons.

- A (hold) - to scroll upward through the Set Points from Air to 21 through 100% (8/sec) in 1% increments. The scroll stops when the button is released, or at 32, 50, and 80% (even if A is held depressed).
- A (hold) again - to restate the scroll, then stop at Air (or 21).
- A (< 2 sec) - to step upward through Set Points.
- M (< 2 sec) - to step back through Set Points.
- S (< 2 sec) - to save the setting and access the next Set FO2 selection.
- S (2 sec), if the Set Point is not changed - to step back to the Lead-in screen or the previous set selection.

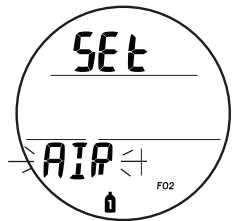

Fig. 47A - SET FO2 GAS 1 (for Air)

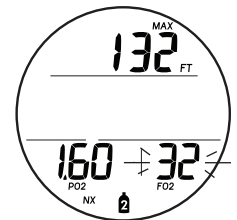

Fig. 47B - SET FO2 GAS 2 (for Nitrox)

**Set FO2 50% Default**, information includes (Fig. 48):

- > Graphics SET, DFLT, and 50 with FO2 icon, solid.
- > Set Point graphic OFF (or ON), flashing.

- A or M (< 2 sec) - to toggle between ON and OFF.
- S (< 2 sec) - to save the setting and revert to Set F Lead-in.
- S (2 sec), if the Set Point is not changed - to step back to Set FO2 Gas 3.

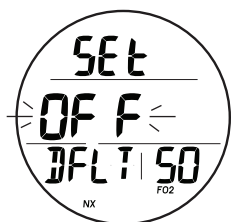

Fig. 48 - SET FO2 DEFAULT

**SET A GROUP (ALARMS), NORM/GAUG**

Selections >> Aud > Depth > EDT > Turn > End > TLBG\* > DTR\* > PO2\*

\*Items apply to NORM only.

> Set Points remain as set until changed.

**Set A Lead-in**, information includes (Fig. 49):

> Graphics Goto and SET A.

- A (< 2 sec) - to step forward to SET U.
- M (< 2 sec) - to step back to SET F.
- S (< 2 sec) - to access Set Audible Alarm.

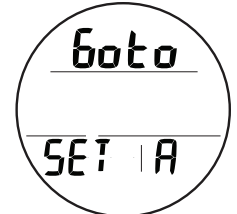

Fig. 49 - SET A LEAD-IN

**Set Audible Alarm**, information includes (Fig. 50):

> Graphics SEt and AUD AL.  
> Set Point graphic ON (or OFF) flashing.

- A or M (< 2 sec) - to toggle between ON and OFF.
- S (< 2 sec) - to save the setting and access Set Depth Alarm.
- S (2 sec), if no change - to revert to Set A Lead-in.

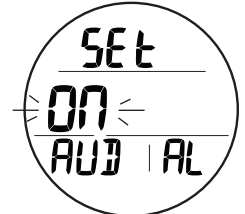

Fig. 50 - SET AUD AL

**Set Depth Alarm**, information includes (Fig. 51):

> Graphics SEt and DPTH AL.  
> Set Point graphic OFF (or Depth value) flashing with FT (or M) icon.

- A (hold) - to scroll upward through Set Points (8/sec) from OFF to 30 through 330 FT (10 through 100 M) in increments of 10 FT (1 M).
- A (< 2 sec) - to step upward through Set Points.
- M (< 2 sec) - to step back through Set Points.
- S (< 2 sec) - to save the setting and access Set EDT Alarm.
- S (2 sec), if no change - to revert to Set Audible.

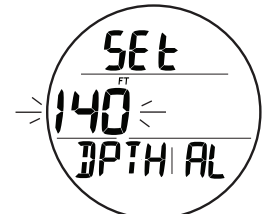

Fig. 51 - SET DEPTH AL

**Set EDT Alarm**, information includes (Fig. 52):

> Graphics SEt and EDT AL.  
> Set Point graphic OFF (or Time value) flashing with min icon.

- A (hold) - to scroll upward through Set Points (8/sec) from OFF to 10 through 180 (min) in increments of 5 min.
- A (< 2 sec) - to step upward through Set Points.
- M (< 2 sec) - to step back through Set Points.
- S (< 2 sec) - to save the setting and access Set TLBG Alarm.
- S (2 sec), if no change - to revert to Set Depth Alarm.

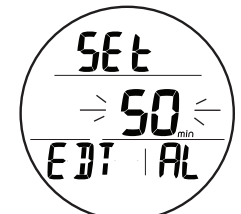

Fig. 52 - SET EDT AL

**Set TLBG Alarm (NORM)**, information includes (Fig. 53):

> Graphics SEt and TLBG AL.  
> Set Point graphic OFF (or TLBG segments) flashing.

- A (< 2 sec) - to step upward through Set Points from OFF to 1 through 4 segments.
- M (< 2 sec) - to step back through Set Points.
- S (< 2 sec) - to save the setting and access Set DTR Alarm.
- S (2 sec), if no change - to revert to Set EDT Alarm.



Fig. 53 - SET TLBG AL

**Set DTR Alarm (NORM)**, information includes (Fig. 54):

> Graphics SEt and DTR AL.  
> Set Point graphic OFF (or Time value) flashing with min icon.

- A (hold) - to scroll upward through Set Points (8/sec) from OFF to 1 through 20 (min) in increments of 1 min.
- A (< 2 sec) - to step upward through Set Points.
- M (< 2 sec) - to step back through Set Points.
- S (< 2 sec) - to save the setting and access Set Turn Alarm.
- S (2 sec), if no change - to revert to Set TLBG Alarm.



Fig. 54 - SET DTR AL

**Set Turn Alarm (TMT1 only)**, information includes (Fig. 55):

> Graphics SEt and TURN AL with Tank 1 icon.  
> Set Point graphic OFF (or Pressure value) flashing, with PSI (or BAR) icon.

- A (hold) - to scroll upward through Set Points (8/sec) from OFF to 1000 to 3000 PSI (70 to 205 BAR) in 250 PSI (5 BAR) increments.
- A (< 2 sec) - to step upward through Set Points.
- M (< 2 sec) - to step back through Set Points.
- S (< 2 sec) - to save the setting and access Set End Alarm.
- S (2 sec), if no change - to revert to Set DTR Alarm.



Fig. 55 - SET TURN AL  
(applies to TMT 1 only)

**Set End Alarm** (TMT 1, 2, 3) information includes (Fig. 56):

- > Graphics SET and END AL with all Tank icons (1, 2, 3).
  - > Set Point graphic OFF (or Pressure value) flashing, with PSI (or BAR) icon.
- A (hold) - to scroll upward through Set Points (8/sec) from 300 to 1500 PSI (20 to 105 BAR) in 100 PSI (5 BAR) increments.
  - A (< 2 sec) - to step upward through Set Points.
  - M (< 2 sec) - to step back through Set Points.
  - S (< 2 sec) - to save the setting and access Set PO2 Alarm.
  - S (2 sec), if no change - to revert to Set Turn Alarm.



Fig. 56 - SET END AL (applies to TMT in use)

**Set PO2 Alarm** (NORM), information includes (Fig. 57):

- > Graphic SET and AL.
  - > PO2 value (ATA) flashing with icon.
- A (< 2 sec) - to step upward through Set Points from 1.20 to 1.60.
  - M (< 2 sec) - to step back through Set Points.
  - S (< 2 sec) - to save the setting and revert to Set A Lead-in.
  - S (2 sec), if no change - to revert to Set End Alarm.

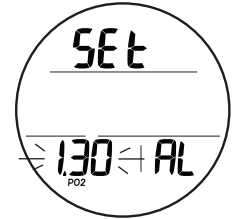

Fig. 57 - SET PO2 AL

**SET U GROUP (UTILITIES)**

Selections >> Wet > Units > DS\* > SS\* > Algo\* > CF\* > Glo > SR > TMT 1 > TMT 2 > TMT 3.

- > Set Points remain as set until changed.

\*Items apply to NORM only.

**Set U Lead-in**, information includes (Fig. 58):

- > Graphics Goto and SET U.
- A (< 2 sec) - to step forward to Select DIVE OP mode.
  - M (< 2 sec) - to step back to SET A.
  - S (< 2 sec) - to access Set Wet.

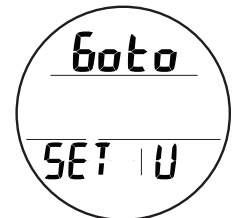

Fig. 58 - SET U LEAD-IN

**Set Wet Activation**, information includes (Fig. 59):

- > Graphics SET and WET.
  - > Set Point graphic ON (or OFF) flashing.
- A or M (< 2 sec) - to toggle between ON and OFF.
  - S (< 2 sec) - to save the setting and access Set Units.
  - S (2 sec), if no change - to revert to SET U.



Fig. 59 - SET WET ACTIVATION

**Set Units**, information includes (Fig. 60):

- > Graphic SET and UNIT.
  - > Set Point icons FT and PSI (or M and BAR) flashing.
- A or M (< 2 sec) - to toggle between FT/PSI and M/BAR.
  - S (< 2 sec) - to save the setting and access Set DS if NORM, or Set Glo if GAUG.
  - S (2 sec), if no change - to revert to Set Wet.

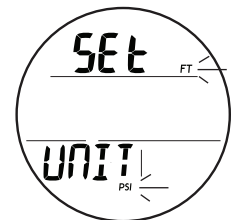

Fig. 60 - SET UNITS

**Set DS (NORM Deep Stop)**, information includes (Fig. 61):

- > Graphic SET and DEEP St with Stop arrow/bar icons.
  - > Set Point graphic ON (or OFF) flashing.
- A or M (< 2 sec) - to toggle between ON and OFF.
  - S (< 2 sec) - to save the setting and access Set SS.
  - S (2 sec), if no change - to revert to Set Units.



Fig. 61 - SET DS

When set On, the Deep Stop feature activates when descent is made to a depth deeper than 80 FT (24 M) during No Deco.

A Stop Depth is calculated to be 1/2 the Max Depth achieved, then upon ascent to within 10 FT (3 M) below that depth, the Deep Stop screen is displayed in place of the No Deco Main.

**Set SS (NORM Safety Stop)**, information includes (Fig. 62):

- > Graphics SEt and SAFE St with Stop arrow/bar icons.
- > Set Point graphic ON (or OFF) flashing.

- or -

- > Graphic SEt with Stop arrow/bar icons.
- > Set Point graphic ON TMR flashing.

- A (< 2 sec) - to step forward through the Set Points (SAFE St OFF, SAFE St ON, TMR ON).
- S (< 2 sec) - to save the setting.
- S (2 sec), if no change - to revert to Set DS.

>> If SS OFF (Fig. 60A, page 58) or TMR ON (Fig. 60B) is selected, operation accesses Set Algorithm.  
 >> If SS ON is selected, Stop Depth and Time is displayed with min and sec icons, Time digits flashing (Fig. 60C).

- A or M (< 2 sec) - to toggle Stop Time Set Points between 3:00 and 5:00 (min:sec).
- S (< 2 sec) - to save the Time setting and flash Depth digits.
- A (< 2 sec) - to step up through Depth Set Points of 10, 15, and 20 FT (or 3, 4, 5, and 6 M).
- M (< 2 sec) - to step back through Set Points.
- S (< 2 sec) - to save the setting and access Set Algorithm.

**Set Algorithm (NORM)**, information includes (Fig. 63):

- > Graphics SEt and ALGO.
- > Set Point graphic PZ+ (or DSAT) flashing.

- A or M (< 2 sec) - to toggle between DSAT and PZ+.
- S (< 2 sec) - to save the setting and access Set CF.
- S (2 sec), if no change - to revert to Set SS.

*This feature allows selection of the Algorithm to be used for nitrogen and oxygen calculations for Plan and Dive allowed time values.*

*The setting locks in for 24 hours after NORM dives.*

**Set CF (Conservative Factor, NORM)**, information includes (Fig. 64):

- > Graphics SEt and CF with icon.
- > Set Point graphic ON (or OFF) flashing.

- A or M (< 2 sec) - to toggle between ON and OFF.
- S (< 2 sec) - to save the setting and access Set Glo.
- S (2 sec), if no change - to revert to Set Algorithm.

*When CF is set On, NDLs are reduced to values equivalent to those that would be available at the next higher 3000 foot (915 meter) Altitude. Refer to tables in back of manual.*

**Set Glo (Backlight Duration)**, information includes (Fig. 65):

- > Graphics SEt and GLO.
- > Time Set Point value flashing with sec icon.

- A (< 2 sec) - to step upward through Set Points of 0, 5, and 10 (sec) one at a time.
- M (< 2 sec) - to step back through Set Points one at a time.
- S (< 2 sec) - to save the setting and access Set SR.
- S (2 sec), if no change - to revert to Set CF.

*Backlight Duration is the time the backlight will remain On after the L button is released (0 = no additional time).*

**Set SR (Sampling Rate)**, information includes (Fig. 66):

- > Graphics SEt and SR.
- > Time Set Point value flashing with sec icon.

- A (< 2 sec) - to step upward through Set Points of 2, 15, 30, and 60 (sec) one at a time.
- M (< 2 sec) - to step back through Set Points one at a time.
- S (< 2 sec) - to save the setting and access Set TMT 1.
- S (2 sec), if no change - to revert to Set Glo.

*Sampling Rate is the frequency at which data is sampled and stored for download to the OceanLog PC Interface program.*

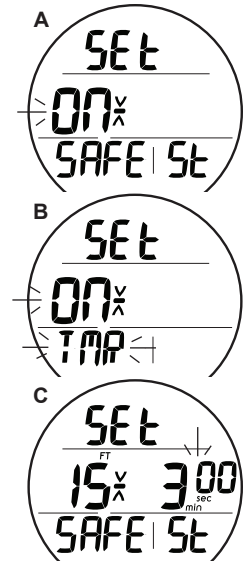

Fig. 62 - SET SS

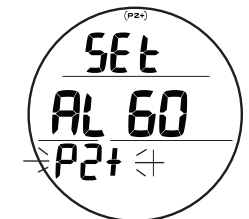

Fig. 63 - SET ALGORITHM

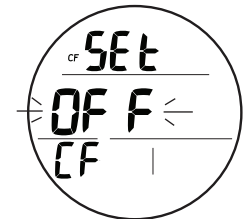

Fig. 64 - SET CF

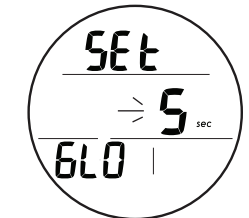

Fig. 65 - SET GLO

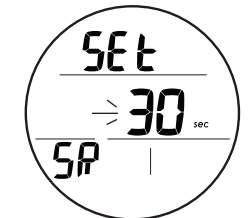

Fig. 66 - SET SR

**Set TMT 1**, information includes (Fig. 67):

- > Graphics SEt and TMT1 with Tank 1 icon.
- > Set Point graphic OFF (or ON) flashing.

- A (< 2 sec) - to step forward through the selections of OFF, ON, and SN.
- M (< 2 sec) - to step back through the selections.
- S (< 2 sec) - to save the selection.
- S (2 sec), if no change - to step back to Set SR.

- > *If OFF is selected, the Receiver is disabled, Set TMT 2, and Set TMT 3 will be bypassed, and operation reverts to the Set U Lead-in screen.*
- > *If ON is selected, the Receiver is enabled and operation advances to Set TMT 2.*
- > *If SN is selected, the Set TMT 1 SN screen is displayed.*

**Set TMT 1 SN** (Link Code), information includes (Fig. 68):

- > Graphics SEt and TMT1 SN with Tank 1 icon.
- > Serial Number (Link Code up to 6 digits), left digit flashing.

- A (< 2 sec) - to step upward through the first digit's Set Point values one at a time.
- M (< 2 sec) - to step back through Set Points one at a time.
- S (< 2 sec) - to save the first digit and flash the second.  
*\*\*Repeat A/M and S operations to set the other digits.*
- When S is pressed to save the last (right) digit, operation reverts to the Set TMT 1 screen with SN flashing.



Fig. 67 - SET TMT 1  
(Set TMT 2 & 3 similar)

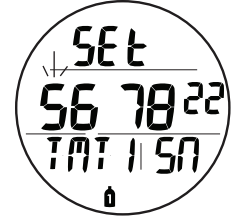

Fig. 68 - SET TMT 1 SN  
(Set TMT 2 & 3 SN similar)

**>> Set TMT 2 & 3 are similar to Set TMT 1.**

**Note that Figures 69 to 72 are no longer used.**

**SELECT DIVE OP (OPERATING) MODE**

Selections >> NOR > GAU > FRE.

**Lead-in**, information includes (Fig. 73):

- > Graphics Goto, SEL, and DIVE OP.
- A (< 2 sec) - to step forward to History.
- M (< 2 sec) - to step back to SET U.
- S (< 2 sec) - to access Select Dive Op Mode.



Fig. 73 - SET M LEAD-IN

**Select Dive Op Mode**, information includes (Fig. 74):

- > Graphics SEL and DIVE OP.
- > Mode graphic flashing.
- A (< 2 sec) - to step forward through selections of NOR, GAU, and FRE.
- M (< 2 sec) - to step back through selections.
- S (< 2 sec) - to save the selection and revert to that mode's Surface Main screen.
- S (2 sec), if no change - to revert to the Lead-in.



Fig. 74 - SELECT DIVE OPERATING MODE

**NOR = Normal (scuba with Ni-O2 calculations).**

**GAU = Gauge (scuba with depth & time).**

**FRE = Free (breath hold dives).**

**HISTORY MODE (NORM/GAUG)**

History is a summary of basic data recorded during all NORM and GAUG dives conducted.

**History 1**, information includes (Fig. 75):

- > Total number dives recorded (up to 9999), 0 if no dive yet. *At top of screen, no icons.*
- > Total dive time recorded (up to 9999 hours) with graphic Hr and EDT icon.
- > Graphic HIST.



Fig. 75 - HISTORY 1

- A (< 2 sec) - to step forward to Serial Number.
- M (< 2 sec) - to step back to Select Dive OP Mode.
- S (< 2 sec) - to access History 2.

**History 2**, information includes (Fig. 76):

- > Graphic SEA (or EL2 to EL7), highest Altitude at which a dive was conducted.
- > Max Depth recorded (to 330 FT/100 M) with MAX and FT (or M) icons.
- > Longest dive time recorded during a single dive (up to 599 min) with EDT and min icons.
- > Lowest Temperature recorded while in dive mode with icon and graphic F (or C).



Fig. 76 - HISTORY 2

- S (< 2 sec) to revert to History 1.

**SERIAL NUMBER**

This information should be recorded and kept, it will be required in the event that your unit requires factory service.

**Serial Number**, information includes (Fig. 77):

- > Graphic SN with the factory programmed serial number.
- > Graphics REV - and 1A (or higher), indicating the Firmware revision level currently installed in the unit.
- A (< 2 sec) - to step forward to BATT/TMT Status.
- M (< 2 sec) - to step back to History 1.



Fig. 77 - SERIAL NUMBER

**BATTERY/TMT STATUS**

This feature activates the unit's receiver, then after 2 seconds, starts an automatic scroll displaying a sequence of Status screens.

**Lead-in**, information includes (Fig. 78):

- > Graphics Goto, bAtt, and TMT.
- A (< 2 sec) - to step forward to Surface Main.
- M (< 2 sec) - to step back to SN.
- S (< 2 sec) - to activate the receiver and start the sequence.



Fig. 78 - BATT/TMT STATUS LEAD-IN

Sequence of Status screens >>

- > ATOM's Battery Status for 3 sec.
- > TMT 1 Status for 3 sec.
- > TMT 2 Status for 3 sec.
- > TMT 3 Status for 3 sec.
- > revert to BATT/TMT Lead-in.



**ATOM Batt Status**, information includes (Fig. 79):

- > Graphics bAtt and ATOM.
- > Graphic Good (if => 2.75 v) or LOW (if < 2.75 v).
- > Battery icon, if Low (< 2.75 v), flashing (if < 2.50 v).

**TMT Status**, information includes:

- > Graphics bAtt and Good (or LOW) (Fig. 80).
- > Tank Pressure with PSI (or BAR), Link, and Tank 1 (or 2, 3) icons, if the TMT is active and reporting.  
- or -
- > Graphics Not AVAIL with Tank 1 (or 2, 3) icon (Fig. 81), if the TMT is not in use or not reporting (no link signal).



Fig. 79 - ATOM BATT STATUS



Fig. 80 - TMT STATUS

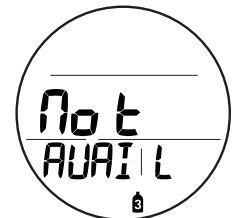
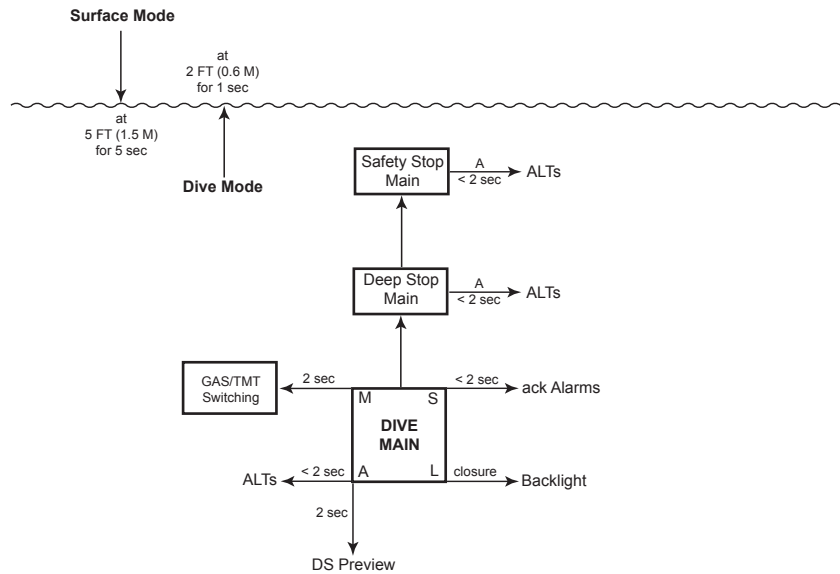

Fig. 81 - TMT STATUS

# **DIVE MODE FEATURES**

**NORM DIVE MODE STRUCTURE**



**TRANSMITTER SIGNAL RECEPTION GUIDE**

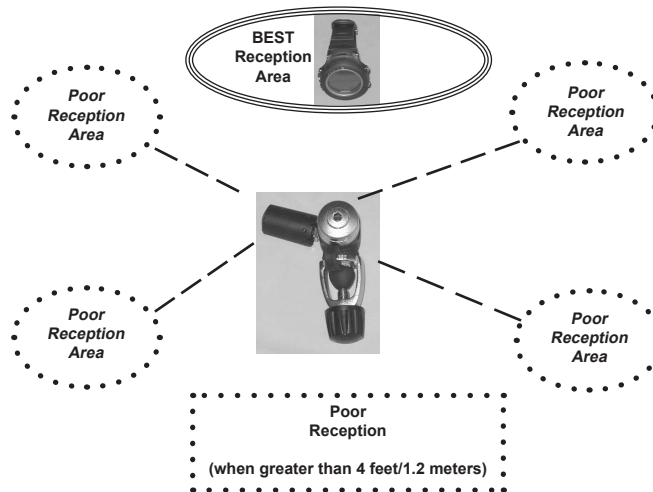

**PROXIMITY of the TMTs (Transmitters) to the ATOM 3.0**

The TMTs emit low frequency signals that radiate out in semicircular patterns parallel to the length dimension of the TMT. A coiled antenna inside the ATOM receives the signals when it is positioned within a zone parallel to or at a 45 degree angle to the TMT as illustrated.

The ATOM cannot effectively receive a signal when it is held out to the sides of the TMT or held at distances greater than 4 feet (1.2 meters) in front of the TMT. Best reception is achieved when the ATOM is within 3 feet (1 meter) of the TMT.

When installed into the high pressure ports of the Regulator First Stages, the TMTs must be positioned so that they face horizontally outward from the Tank Valves.

**Link Interruption Underwater**

During a dive, you may at times move the ATOM out of the signal pattern of the TMT, resulting in a temporary loss of the Link signal. The Link will be restored within 4 seconds after the ATOM is moved back into its correct position.

An interruption may also occur while the ATOM is within 3 feet (1 meter) of a running DPV. The Link will be restored within 4 seconds after the ATOM is moved out of that area.

A temporary interruption may also occur shortly after a Strobe flashes. The Link will be restored within 4 seconds.

If the Link is not restored within 15 seconds, the Audible will sound, and the Pressure value and Link icon will flash (Fig. 82).

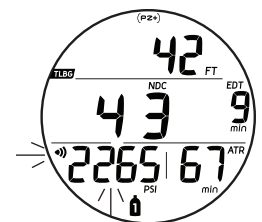

Fig. 82 - LOST LINK

**BAR GRAPHS**

The ATOM features 2 specific bar graphs.

- > The one on the left represents nitrogen loading. It is referred to as the TLBG (Tissue Loading Bar Graph).
- > The one on the right represents ascent rate. It is referred to as the VARI (Variable Ascent Rate Indicator).

**TLBG (NORM/FREE)**

The TLBG represents your relative No Deco (Fig. 83a) or Deco status (Fig. 84a). The lower 4 segments represent No Deco status and the top one indicates a Deco condition.

As your Depth and Elapsed Dive Time increase, segments add.

As you ascend, segments recede indicating that additional No Deco time is available.

The ATOM monitors 12 different nitrogen compartments simultaneously and the TLBG displays the one that is in control of your dive at any given time.

**VARI (NORM/GAUG)**

The VARI (Fig. 85a) provides a visual representation of ascent speed (i.e., an ascent speedometer).

The segments represent two sets of speeds which change at a reference depth of 60 FT (18 M). Refer to the chart.

When ascent is too fast, the audible will sound, and all VARI segments will flash (Fig. 86) until ascent is slowed.

**⚠ WARNING: When deeper than 60 FT (18 M), ascent rates should not exceed 60 FPM (18 MPM). At depths of 60 FT (18 M) and shallower, ascent rates should not exceed 30 FPM (9 MPM).**

Deeper than 60 FT (18 M)			60 FT (18 M) & Shallower		
VARI Segments	Ascent Rate FPM	MPM	VARI Segments	Ascent Rate FPM	MPM
0	0 - 20	0 - 6	0	0 - 10	0 - 3
1	21 - 30	6.1 - 9	1	11 - 15	3.1 - 4.5
2	31 - 40	9.1 - 12	2	16 - 20	4.6 - 6
3	41 - 50	12.1 - 15	3	21 - 25	6.1 - 7.5
4	51 - 60	15.1 - 18	4	26 - 30	7.6 - 9
5	60 +	18 +	5	30 +	9 +

**ALGORITHM**

The ATOM is configured with 2 algorithms which allows you to choose which set of NDLs (No Deco Limits) will be used for nitrogen/oxygen (Ni/O2) calculations and displays relating to Plan and Dive Time Remaining (DTR).

You can select to use either the DSAT or the PZ+. The selection will lock in for 24 hours after the last dive.

*DSAT has been the standard used by Oceanic in all of its dive computers until this time. It features NDLs that are based on exposures and test data which also formed validation for the PADI RDP. It imposes restrictions for repetitive Deco dives, considered more risky.*

*PZ+ (Pelagic Z+) performance is based on Buhlmann ZHL-16c. It features NDLs that are considerably more conservative especially at shallower depths.*

To create even greater margins of safety with respect to decompression, a Conservative Factor as well as No Deco Deep and Safety Stops can be included for No Deco dives.

**CONSERVATIVE FACTOR (CF)**

When the CF is set On, the allowable dive times, which are based on the algorithm selected and used for Ni/O2 calculations and displays relating to Plan and Dive Time Remaining, will be reduced to the values available at the altitude level that is 3,000 feet (915 meters) higher. Refer to the charts in the back of this manual for times.

**DEEP STOP (DS), NORM No Deco only**

When the DS selection is set On, it will trigger during NORM No Deco dives when you descend to 80 FT (24 M), then calculate (and continually update) a Stop Depth equal to 1/2 the Max Depth.

While 10 FT (3 M) deeper than the calculated DS, you will be able to access a DS Preview screen that will display the current DS Stop Depth/Time.

Upon initial ascent to within 10 FT (3 M) below the calculated Stop Depth, a DS screen displaying a Stop Depth at 1/2 the Max Depth will appear with a Countdown Timer beginning at 2:00 (min:sec) and counting down to 0:00.

- > If you descend 10 FT (3 M) below, or ascend 10 FT (3 M) above, the calculated Stop Depth for 10 seconds during the countdown, the No Deco Main will replace the DS Main display and the DS feature will be disabled for the remainder of that dive. There is no Penalty if the DS is ignored.
- > In the event that you enter Deco, exceed 190 FT (57 M), or a High O2 condition (=> 80%) occurs, the DS will be disabled for the remainder of that dive.
- > The DS is disabled during a High PO2 Alarm condition (=> Set Point).

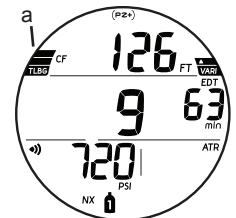

Fig. 83 - NO DECO

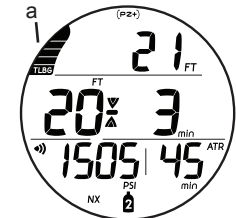

Fig. 84 - DECO



Fig. 85 - DIVE MAIN (Ascent normal)

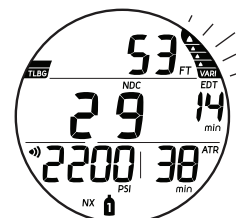

Fig. 86 - DIVE MAIN (Ascent Too Fast)

**SAFETY STOP (SS), NORM No Deco only**

**If set On:**

Upon ascent to within 5 FT (1.5 M) deeper than the SS Depth set for 1 second on a No Deco dive in which Depth exceeded 30 FT (9 M) for 1 second, a beep will sound and a SS at the Depth set will appear on the Main display with a countdown beginning at the SS Time set and counting down to 0:00 (min:sec).

- If the SS was set for OFF or Timer, the display will not appear.
- In the event that you descend 10 FT (3 M) deeper than the Stop Depth for 10 seconds during the countdown, or the countdown reaches 0:00, the No Deco Main screen will replace the SS Main screen which will reappear upon ascent to within 5 FT (1.5 M) deeper than the Safety Stop Depth set for 1 second.
- In the event that you enter Deco during the dive, complete the Deco obligation, then descend below 30 FT (9 M); the SS Main will appear again upon ascent to within 5 FT (1.5 M) deeper than the SS Depth set for 1 second.
- If you ascend 2 FT (0.6 M) shallower than the SS Depth for 10 seconds prior to completing it, the SS will be canceled for the remainder of that dive.
- There is no Penalty if you surface prior to completing the SS or ignore it.

**If set for Timer On:**

Upon ascending to 20 FT (6 M) for 1 second on a No Deco dive in which Depth exceeded 30 FT (9 M) for 1 second, 1 beep will sound and a Run Timer will appear (if set On) displaying 0:00 (min:sec) until started.

- If the SS was set for Off or On, the Timer display will not appear.
- If you descend deeper than 30 FT (9 M) for 10 seconds, the No Deco Main will replace the Timer screen which will reappear upon ascent to 20 FT (6 M) for 1 second.
- If you ascend above 10 FT (3 M) for 10 seconds, or enter Deco, or a High O2 alarm condition occurs (100%), while the SS Timer is active, the SS Timer will be disabled for the remainder of that dive.

**DIVE TIME REMAINING (DTR)**

The ATOM constantly monitors No Deco status (nitrogen loading) and O2 accumulation, and will use whichever time is the least available to calculate DTR.

Either NDC or OTR is displayed as the main time (Fig. 87). The NDC or O2 icon will signify which time is being displayed.

**NDC (No Deco Dive Time Remaining)**

NDC is the maximum amount of time that you can stay at your present depth before entering decompression. It is calculated based on the amount of nitrogen absorbed by hypothetical tissue compartments.

- The rates each of these compartments absorb and release nitrogen is mathematically modeled and compared against a maximum allowable nitrogen level.
- Whichever one is closest to this maximum level is the controlling compartment for that depth. Its resulting value will be displayed numerically as NDC time remaining (Fig. 87a) and graphically as the TLBG (Fig. 87b).
- As you ascend, TLBG segments will recede as control shifts to slower compartments. This feature of the decompression model is the basis for multilevel diving, one of the most important advantages that Oceanic dive computers offer.

**OTR (O2 Dive Time Remaining)**

When set for Nitrox operation, O2 during a dive is displayed on an ALT screen as a % of total exposure allowed (Fig. 88a).

The limit for oxygen exposure (100%) is 300 OTU (oxygen tolerance units) per dive or 24 hour period.

As time before reaching the limit decreases, % O2 increases and oxygen time remaining (OTR) decreases.

When OTR becomes less than the NDC, calculations for the dive will be controlled by O2 and OTR will be displayed on the Main (Fig. 89a), with the O2 icon. NDC will then be displayed on an ALT screen that can be accessed.

**ATR (Air Time Remaining)**

The ATOM calculates ATR using a patented algorithm that is based on the diver's air consumption rate and current depth.

ATR is the time you can remain at the present depth and still safely surface with the tank pressure reserve that you selected during setup (End Pressure alarm setting).

Tank pressure is measured once each second and an average rate of consumption is calculated over a 90 second period, and used in conjunction with the depth to predict the amount of air required to make a safe controlled ascent, including the No Deco Deep and Safety Stops and any required Deco Stops.

Air consumption and depth are continuously monitored and ATR reflects any change in circumstances, such as beginning to breath more rapidly when swimming against a current which the ATOM will recognize as a change and adjust ATR accordingly.

ATR is displayed numerically (from 0 to 199\* min) on the Dive Main screen (Fig. 90a).

\*ATR remains at 199 min when => 199 minutes.

**ATR Alarm**

When ATR (Air Time Remaining) decreases to 5 minutes, the audible will sound and the ATR digits will flash (Fig. 91). If it decreases to 0, the audible will sound again. The digits will continue to flash until ATR becomes greater than 5 minutes.

*Action (upon activation of the alarm) >> You should initiate a controlled ascent while monitoring tank pressure. However, there is no reason to panic, the ATOM has allowed for the air necessary for a safe ascent including the No Deco Deep and Safety Stops, if set on, and any Deco Stops required.*

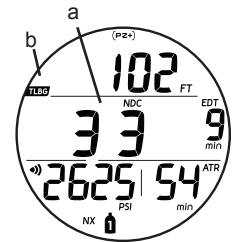

Fig. 87 - NO DECO MAIN (NDC is DTR)

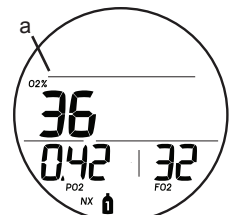

Fig. 88 - NO DECO ALT 2 (O2 data)

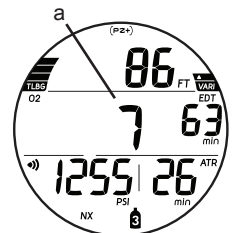

Fig. 89 - NO DECO MAIN (OTR is DTR)

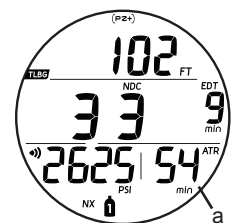

Fig. 90 - DIVE MAIN (ATR as normally seen)

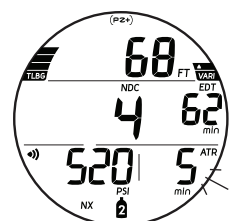

Fig. 91 - DIVE MAIN (ATR Alarm)

# **NORM**

## **DIVE MODES**

**NO DECO DIVE MAIN**, information includes (Fig. 92):

- > Current Depth with FT (or M) icon.
- > DTR (min) with NDC (or O2) icon, up to 199.
- > Elapsed Dive Time with EDT and min icons, up to 199.
- > Tank Pressure with Link and PSI (or BAR) icons.
- > Air Time Remaining with ATR and min icons, up to 199.
- > TLBG, and VARI (while ascending).
- > NX, (PZ+), CF, Gas/TMT, DS icons - if they apply.

- A (< 2 sec) - to access ALTs.
- A (2 sec) - to access Deep Stop Preview, if triggered.
- M (2 sec) - to access Gas/TMT Switching.
- S (< 2 sec) - to acknowledge/silence alarms.
- L (press) - to activate Backlight.

Upon ascending to 2 FT (0.6 M) during a dive, Surface Interval time will be displayed with the SURF icon flashing for the first 10 minutes and NDC will be displayed as 2 dashes (Fig. 93).

- A (< 2 sec) - to access Dive ALTs.
- M (2 sec) - to access Gas/TMT Switching.
- L (press) - to activate Backlight.

>> After 10 minutes elapse, the display will revert to the Surface Main and full access will be given to NORM Surface items.  
 >> If a descent is made to 5 FT (1.5 M) for 5 seconds, the dive will be continued.  
 >> Surface time will not be added to Dive Time.

**No Deco Alt 1**, information includes (Fig. 94):

- > Max Depth with MAX and FT (or M) icons.
- > Time of Day (hr:min\_sec), with AM (or PM) icon if 12 Hour Format, no icon if 24 Hour Format.
- > Temperature with ° icon and graphic F (or C).

- A (< 2 sec) - to access ALT 2 (if Nitrox).
- Revert to Main in 5 sec, if A is not pressed.
- L (press) - to activate Backlight.

**No Deco Alt 2** (only if Nitrox), information includes (Fig. 95):

- > O2 accumulated\* with O2% icon.
- \*This is the % of the per dive or per day allowed max limit of 300 OTU.*
- > Current PO2 value (ATA) with PO2 icon.
- > FO2 Set Point (21 to 100%) for gas in use with FO2 icon.
- > Gas (tank) icon for gas in use (1, 2, 3).

- 5 sec or A (< 2 sec)\*\* - to revert to Main.
- L (press) - to activate Backlight.

\*\*When OTR is displayed on the Main (which is only when it is < NDC), NDC will be displayed as the ALT 3 screen which can be accessed from ALT 2 by A (< 2 sec).

**Deep Stop Preview**, information includes (Fig. 96):

- > DS icon with graphic PREV.
- > Current Depth with FT (or M) icon.
- > Stop Depth\* with FT (or M) icon, Stop icon (arrows, bar), and Stop Time as 2\_00 with min and sec icons.
- \*Calculated as 1/2 Max Depth after depths => 80 FT (24 M).*

- 5 sec or A (< 2 sec) - to revert to Main.
- L (press) - to activate Backlight.

**DEEP STOP MAIN**, information includes (Fig. 97):

- > DS icon.
- > Current Depth with FT (or M) icon.
- > Stop Depth with FT (or M) icon, Stop icon (arrows, bar), and Stop Time (counting down) with min and sec icons.
- > Tank Pressure with Link and PSI (or BAR) icons.
- > Air Time Remaining with ATR and min icons.
- > TLBG.
- > NX, (PZ+), CF, Gas/TMT icons - if they apply.

- A (< 2 sec) - to access ALTs\*\*.
- M (2 sec) - to access Gas/TMT Switching.
- S (< 2 sec) - to acknowledge/silence alarms.
- L (press) - to activate Backlight.

\*\* DS features up to 3 ALT displays which are similar to the No Deco Main, ALT1, and ALT2 displays, respectively.

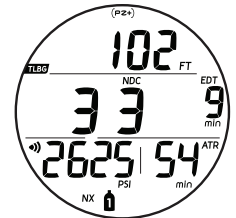

Fig. 92 - NO DECO MAIN

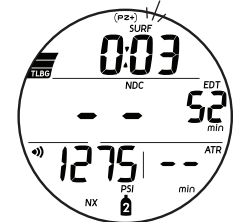

Fig. 93 - NO DECO MAIN (during < 10 min on surface)

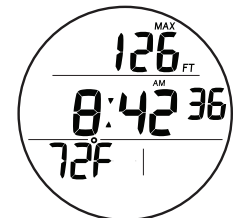

Fig. 94 - NO DECO ALT 1

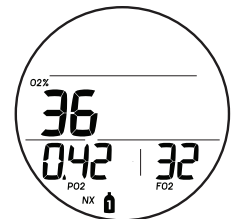

Fig. 95 - NO DECO ALT 2

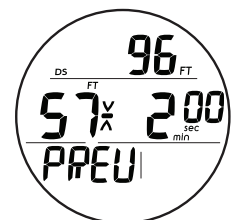

Fig. 96 - DS PREVIEW

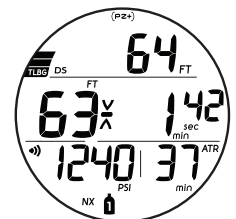

Fig. 97 - DS MAIN

**SAFETY STOP MAIN (On)**, information includes (Fig. 98):

- > Current Depth with FT (or M) icon.
- > Stop Depth with FT (or M) icon, Stop icon (arrows, bar), and Stop Time (counting down) with min and sec icons.
- > Tank Pressure with Link and PSI (or BAR) icons.
- > Air Time Remaining with ATR and min icons.
- > TLBG.
- > NX, (PZ+), CF, Gas/TMT icons - if they apply.

- A (< 2 sec) - to access ALTs\*\*.
- M (2 sec) - to access Gas/TMT Switching.
- S (< 2 sec) - to acknowledge/silence alarms.
- L (press) - to activate Backlight.

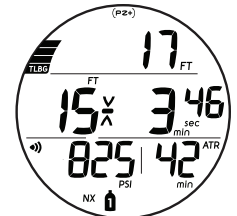

Fig. 98 - SS MAIN  
(On - Depth/Time set)

When the SS is set for Timer, the graphic rt is displayed with Run Time (Fig. 99) counting up from 0\_00 to 9\_59 (min\_sec).

- A (< 2 sec) - to access ALTs\*\*.
- M (2 sec) - to access Gas/TMT Switching.
- S (< 2 sec)\* - to start/stop Timer, and acknowledge alarms.
- S (2 sec)\*, when Timer is stopped - to reset it to 0\_00.

\* Timer operation is blocked when S is pressed to silence alarms.  
\*\* SS features up to 3 ALT displays which are similar to the No Deco Main, ALT1, and ALT2 displays, respectively.



Fig. 99 - SS MAIN  
(set for Run Timer)

**DECOMPRESSION**

Decompression mode activates when theoretical No Decompression time and depth limits are exceeded.

Upon entry into Deco, the audible will sound and the alarm LED will flash. The full TLBG and Up Arrow icon will flash (Fig. 100) until the audible is silenced.

- S (< 2 sec) - to silence Audible.
- > Once within 10 FT (3 M) below the required Stop Depth (stop zone), the Up Arrow will stop flashing and both Arrows with Bar (the Stop icon) will be displayed solid.

To fulfill your decompression obligation, you should make a safe controlled ascent to a depth slightly deeper than, or equal to, the required stop depth indicated and decompress for the stop time indicated.

The amount of decompression credit time that you receive is dependent on depth, with slightly less credit given the deeper you are below the stop depth indicated.

You should stay slightly deeper than the required stop depth indicated until the next shallower stop depth appears. Then, you can slowly ascend to, but not shallower than that indicated stop depth.

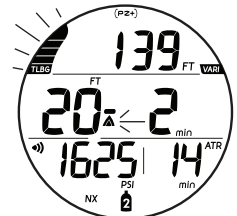

Fig. 100 - DECO ENTRY  
(during audible)

**Deco Stop Main**, information includes (Fig. 101):

- > Current Depth with FT (or M) icon.
- > Stop Depth with FT (or M) icon.
- > Stop icon (arrows/bar).
- > Stop Time with min icon, up to 99 then 2 dashes (- -).
- > Tank Pressure with Link and PSI (or BAR) icons.
- > Air Time Remaining with ATR and min icons.
- > Full TLBG.
- > NX, (PZ+), CF, Gas/TMT icons - if they apply.

- A (< 2 sec) - to access ALTs.
- M (2 sec) - to access Gas/TMT Switching.
- S (< 2 sec) - to acknowledge/silence alarm.
- L (press) - to activate Backlight.



Fig. 101 - DECO STOP MAIN

**Deco Stop Alt 1**, information includes (Fig. 102):

- > Max Depth with MAX and FT (or M) icons.
- > Time of Day (hr:min\_sec) with AM (or PM) icon.
- > Temperature with ° icon and graphic F (or C).

- A (< 2 sec) - to access ALT 2.
- Revert to Main in 5 sec, if A not pressed.
- L (press) - to activate Backlight.



Fig. 102 - DECO STOP ALT 1

**Deco Stop Alt 2**, information includes (Fig. 103) :

- > Elapsed Dive Time with EDT and min icons, up to 199.
- > TAT (min) with TAT and min icons, up to 199.

\*TAT (Total Ascent Time) includes Stop Times at all required Deco Stops plus vertical Ascent Time based on the max rate allowed.

- A (< 2 sec) - to access ALT 2 (if Nitrox), or revert to Main if Air.
- Revert to Main in 5 sec, if A not pressed.
- L (press) - to activate Backlight.

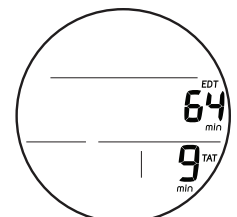

Fig. 103 - DECO STOP ALT 2



**Deco Stop Alt 3** (if Nitrox), information includes (Fig. 104):

- > O2 accumulated\* with O2% icon.
- \*This is the % of the per dive or per day allowed max limit of 300 OTU.*
- > Current PO2 value (ATA) with PO2 icon.
- > FO2 Set Point (21 to 100%) for gas in use with FO2 icon.
- > NX icon.
- > Gas (tank) icon for gas in use (1, 2, 3).
  
- 5 sec or A (< 2 sec) - to revert to Main.
- L (press) - to activate Backlight.

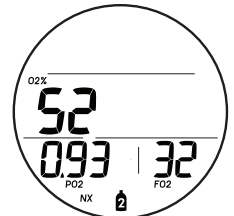

Fig. 104 - DECO STOP ALT 3

**CV (CONDITIONAL VIOLATION)**

Upon ascent above the required Deco Stop Depth, operation will enter CV during which no off gassing credit will be given.

The audible will sound and the alarm LED will flash. The full TLBG and Down Arrow icon will flash (Fig. 105) until the audible is silenced, then the TLBG will be solid.

- S (< 2 sec) - to silence audible.
- > Down Arrow icon continues to flash until descent to below required stop depth (within stop zone), then full Stop icon (stop bar with both arrows) will be on solid.



Fig. 105 - CV MAIN (after Audible)

ALTs are similar to those for Deco.

If you descend deeper than the required Deco Stop before 5 minutes elapse, Deco operation will continue with no off gassing credit given for time above the Stop.

Instead, for each minute above the Stop 1 and 1/2 (1.5) minutes of penalty time will be added to required Stop Time.

- > The added penalty (deco) time will have to be worked off before obtaining off gassing credit.
- > Once the penalty time is worked off, and off gassing credit begins, required Deco Stop Depths and Time will decrease toward zero. The TLBG will recede into the No Deco zone and operation will revert to No Deco mode.

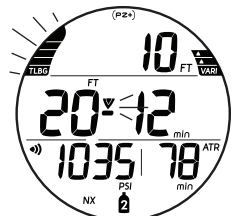

Fig. 106 - DV1 MAIN (during Audible)

**DV 1 (DELAYED VIOLATION 1)**

If you remain shallower than a Deco Stop Depth for more than 5 minutes, operation will enter DV1 which is a continuation of CV\* with penalty time still being added.

The audible will sound and the full TLBG will flash (Fig. 106) until it is silenced.

*\*The difference is that 5 minutes after surfacing from the DV1 dive, operation will now enter Violation Gauge Mode (VGM).*

- > The audible will silence after 10 seconds.
- > Down Arrow icon continues to flash until descent to below required Stop Depth, then full Stop icon will be on solid.

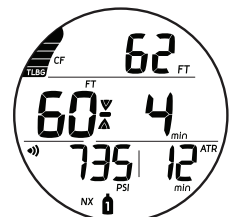

Fig. 107 - DV2 MAIN

**DV 2 (DELAYED VIOLATION 2)**

If the calculated Deco obligation requires a Stop Depth between 60 FT (18 M) and 70 FT (21 M), operation will enter DV2.

The audible will sound and the alarm LED will flash. The full TLBG will flash until the audible is silenced.

- > The audible will silence after 10 seconds.
- > Up Arrow icon flashes if 10 FT (3 M) deeper than the required Stop Depth.
- > Once within 10 FT (3 M) of and below the required Stop Depth (Fig. 107), the Stop icon (both Arrows with Stop Bar) will be displayed solid.

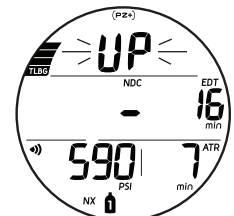

Fig. 108 - DV 3 MAIN

**DV 3 (DELAYED VIOLATION 3)**

If you descend deeper than the MOD\*, the audible will sound and the alarm LED will flash.

Also, the graphic UP will flash in place of Current Depth (Fig. 108).

NDC and Max Depth will only indicate dashes signifying that you are too deep.

*\*MOD is the Max Operating Depth at which the unit can properly perform calculations or provide accurate display information. Refer to the specifications in the back.*

Upon ascending above the MOD, Current Depth will be restored, however, Max Depth will continue to be displayed as dashes for the remainder of that dive. The Log for that dive will also display dashes for Max Depth.

**VGM (VIOLATION GAUGE MODE)**

During NORM dives, operation will enter VGM when Deco requires a Stop Depth greater than 70 FT (21 M). It will also enter VGM if Deco is activated during a dive in FREE mode, described later.

Operation would then continue in VGM during the remainder of that dive and for 24 hours after surfacing.

VGM turns the unit into a digital instrument without any decompression or oxygen related calculations or displays.

Upon activation of VGM, the audible will sound and the alarm LED will flash. The graphics VIO and UP will alternate until on the surface. The full TLBG will flash until the audible is silenced after 10 seconds, then it will be removed.

**VGM Dive Main**, information includes (Fig. 109) -

- > Current Depth with FT (or M) icon.
- > Graphics VIO and UP, alternating.
- > Elapsed Dive Time with EDT and min icons.
- > Tank Pressure with Link and PSI (or BAR) icons.
- > Air Time Remaining with ATR and min icons.
- > VARI while ascending.
- > NX, (PZ+), CF, Gas/TMT icons - if they apply.

- A (< 2 sec) - to access ALTs (similar to Deco).
- M (2 sec) - to access Gas/TMT Switching.
- L (press) - to activate Backlight.

**VGM on Surface**

Upon surfacing, the VGM Dive Main will remain on display for 10 minutes with Surface Interval Time displayed in place of Current Depth with the SURF icon flashing. The graphic VIO will also still be displayed flashing.

Operation will also enter VGM 5 minutes after surfacing from a dive in which a Delayed Violation occurred.

After 10 minutes elapse, the graphic VIO alternates with NOR (Fig. 110) until 24 hours elapse with no dives. Watch functions are as normal.

- > A full 24 hour continuous surface interval must then be served before all dive computer functions are restored.
- > During that 24 hours, VGM does not allow access to the Set F, Plan, Dsat, and FREE Mode features/screens.
- > The Fly countdown indicates time remaining before normal operation can resume with full features and functions.

**HIGH PO2 (NORM ONLY)**

Warning >> at Alarm Set Point value minus 0.20 (1.00 to 1.40).  
 Alarm >> at Set Point value, except in Deco then only at 1.60.

When PO2 (partial pressure of oxygen) increases to the Warning level; the audible sounds, during which the Up Arrow icon will flash (in place of DTR), and the PO2 value will flash (in place of Pressure) until the audible is silenced (Fig. 111).

- S (< 2 sec) - to acknowledge alarm.
- > When the audible is silenced, DTR is restored and the PO2 value will alternate with Pressure until PO2 decreases below the Warning level.

If PO2 continues to increase and reaches the Alarm Set Point; the audible sounds again, during which the Up Arrow icon and PO2 value will flash (in place of DTR and Pressure).

- > When the audible is silenced, the Up Arrow and PO2 value will alternate with NDC and Pressure until PO2 decreases below the Alarm level.

**PO2 Alarm Main**, information includes (Fig. 112) -

- > Current Depth with FT (or M) icon
- > Up Arrow icon, flashing (in place of DTR) until the audible is silenced, then they alternate until < Set Point.
- > PO2 value (ATA) with PO2 icon, flashing (in place of Pressure) until the audible is silenced, then they alternate until < Set Point.
- > TLBG with icon
- > VARI while ascending
- > (PZ+), CF, Gas icons - those that apply

- A (< 2 sec) - to access ALTs (similar to those for No Deco).
- M (2 sec) - to access Gas/TMT Switching.
- L (press) - to activate Backlight.

**High PO2 during Deco** (Fig. 113)

The PO2 alarm that was set does not apply when in Deco.

- > If PO2 reaches 1.60 while at a Deco Stop, the PO2 value with icon will alternate with Pressure once each minute\*.

\*PO2 will be displayed for 10 seconds, then Pressure will be displayed for 50 seconds once each minute until PO2 decreases below 1.60, then PO2 will not be displayed.

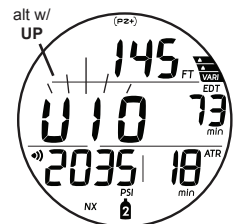

Fig. 109 - VGM MAIN (after Audible)

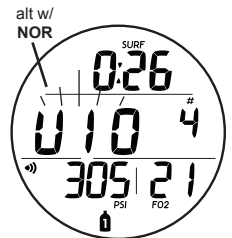

Fig. 110 - VGM MAIN (on surface > 10 min)

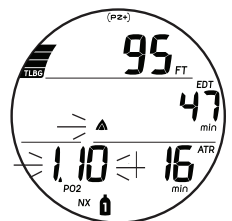

Fig. 111 - PO2 WARNING (during audible)

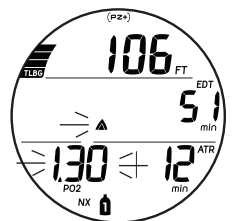

Fig. 112 - PO2 ALARM (during audible)

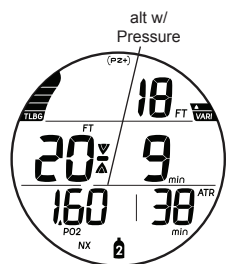

Fig. 113 - PO2 ALARM (while in Deco)

**HIGH O2 (NORM only)**

Warning >> at 80 to 99% (240 OTU).

Alarm >> at 100% (300 OTU).

When O2 reaches the Warning level (80%); the audible sounds during which the O2 value with O2% icon will flash (in place of DTR) (Fig. 114), then DTR will be restored. The O2 icon will remain on flashing (if OTR is DTR) until O2 is < 80%.

If O2 reaches the Alarm level (100%); the audible sounds again, the graphic UP will alternate with the O2 value until on the surface (Fig. 115).

- S (< 2 sec) - to acknowledge/silence alarm.
- A (< 2 sec) - to access ALTs (similar to those for No Deco).
- M (< 2 sec) - to access Gas/TMT Switching.
- L (press) - to activate Backlight.

**High O2 during Deco**

When O2 reaches the Warning Level (80%); the audible sounds during which the O2 value with O2% icon will flash (in place of Stop Depth/Time until the audible is silenced, then Stop Depth/Time will be restored.

- S (< 2 sec) - to acknowledge/silence alarm.

When O2 reaches 100%, the audible sounds and the O2 value with O2% icon will alternate with the graphic UP until on the surface (Fig. 116). The full TLBG remains on solid as a reminder of Deco.

- S (< 2 sec) - to acknowledge/silence alarm.
- A (< 2 sec) - to access ALTs (similar to those for Deco).
- M (< 2 sec) - to access Gas/TMT Switching.
- L (< 2 sec) - to activate Backlight.

**High O2 on Surface**

Upon ascent to 2 FT (0.6 M) for 1 second (surfacing), the Dive Main screen is displayed for 10 minutes with access to the Dive ALTs allowed. Surface Interval Time with the SURF icon flashing (Fig. 117) will be displayed in place of Depth.

- > If O2 is 100%, the value will flash on the Main until it is < 100%, then it will be replaced with dashes (if Violation) until 10 minutes elapse, then the graphic NOR.
- > If you surface due to 100% O2 without having completed the Deco obligation, the full TLBG and O2 value (100%) will flash for the first 10 minutes, then operation will enter VGM.
- > Access to Dive ALTs and Gas/TMT Switching is allowed during the first 10 minutes, then access to the other NORM Surface group selections is allowed.

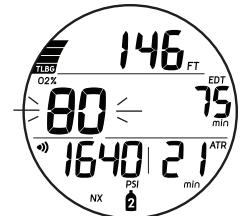

Fig. 114 - O2 WARNING (during audible)

alternate with UP

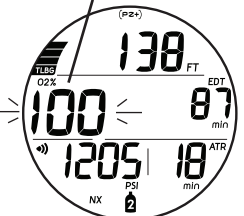

Fig. 115 - O2 ALARM MAIN (No Deco)

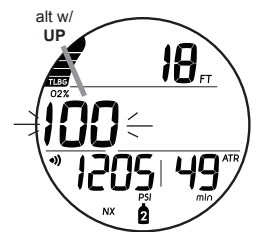

Fig. 116 - O2 ALARM MAIN (during Deco)

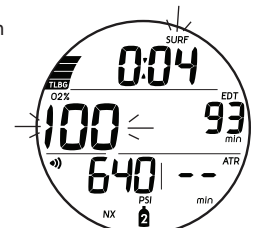

Fig. 117 - O2 ALARM MAIN (on surface, No Deco)

# **GAS/TMT SWITCHING**

**SWITCH ROUTINE OVERVIEW**

- > Can only switch when Dive Main screens are displayed.
  - > Cannot switch on surface, except during first 10 minutes.
  - > Cannot switch during alarms.
  - > All dives begin with Gas/TMT 1 (default on surface).
  - > Defaults to Gas/TMT 1, 10 minutes after surfacing.
- M (2 sec), while a Dive Main is displayed - to access.
  - No button action (10 sec) - to revert to Main.

**NORM Switch Preview**, information includes (Fig. 118):

- > Graphics Goto and GAS 1 (or 2, 3) with # icon.
- > Graphic AIR, or PO2 calculated and FO2 set for that Gas with PO2 and FO2 icons.
- > Gas (tank) icon (1, 2, or 3) for that Gas (TMT).

- M (2 sec) - to step through Preview screens.
- S (2 sec) - to flash the graphic GAS # 1 (2, 3), then -
- S (2 sec) - to confirm a Switch to that Gas (after 2 sec), display a TMT Search screen (Fig. 119) for 10 sec, then revert to Main with that new Gas (and TMT) selected.

*If the Gas/TMT are not switched to the same tank being used, ATR will increase to maximum after 1 minute without a change in Pressure.*

**Gas Switch Warning**

If the switch to a new Gas would result in PO2 => 1.60, the audible will sound and a warning message will flash (Fig. 120) until it is silenced.

*Due to the possibility that sufficient air may not be available (in the switch from tank), the switch will still be allowed.*

*If the switch is made, the PO2 alarm will strike. If in Deco, Up indication will not be given (you control action to be taken).*

**GAUG Switch Preview**, information includes (Fig. 121):

- > Graphics Goto and TMT 1 (or 2, 3).
- > Tank icon (1, 2, or 3) for that TMT.

- M (2 sec) - to step through Preview screens.
- S (2 sec) - to flash the graphic TMT 1 (or 2, 3), then -
- S (2 sec) - to confirm a Switch to that TMT (after 2 sec), display a TMT Search screen for 10 sec, then revert to Main with that new TMT selected.



Fig. 118 - NORM GAS SWITCH PREVIEW



Fig. 119 - TMT SEARCH (Use set for SELF)



Fig. 120 - GAS SWITCH WARNING

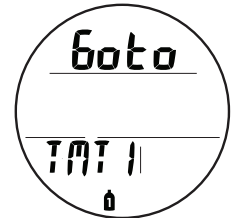

Fig. 121 - GAUG TMT SWITCH PREVIEW

**Note that Figures 122 & 123 are no longer used.**

# DIGITAL GAUGE

## OP MODE

**GAUG SURF MAIN**, information includes (Fig. 124):

- > Surface Interval time (hr:min) with SURF icon; if no dive yet, this is time since mode access.
- > Graphic GAU.
- > Dive number with # icon, up to 24 for that operating period (0 if no dive made yet).
- > TMT 1 Pressure with PSI (or BAR) and link (speaker) icons, if active. #1 is the default in Surface Mode.
- > TMT (tank) 1 icon.
- > Battery icon, if voltage is low.

- M (2 sec) - to access Watch Main.
- A (< 2 sec) - to step forward to GAUG SURF ALT 1.
- M (< 2 sec) - to step back to BATT/TMT.
- L (press) - to activate the Backlight.



Fig. 124 - GAUG SURF MAIN (no dive yet)

Upon surfacing during dives, the Dive Main will remain on display for the first 10 minutes, with Surface Interval time (SI) in place of Depth, after which the Surface Main will be displayed.

The GAUG Surface Group selections are accessed and function similar to those described previously for NORM.

**GAUG SURFACE GROUP**, button operations\* >>

*These operations apply to all group selections that follow, those marked with \* are not repeated when describing each selection.*

- A (< 2 sec) - to step forward through selections.
- A (hold)\* - to scroll forward through selections.
- M (< 2 sec) - to step back through selections.
- M (2 sec, any time)\* - revert to Main.
- No button action (2 min)\* - revert to Main.
- L (press)\* - to activate the Backlight.

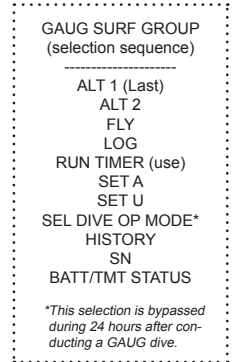

**GAUG SURF ALT 1**, information includes (Fig. 125):

- > SI\* (hr:min) with SURF icon, prior to Last dive.
- > Max Depth\* with MAX and FT (or M) icons.
- > Elapsed Dive Time\* (up to 999) with EDT and min icons.
- > Graphic LAST, indicating data is for dive previously conducted while still in GAUG mode.

- A (< 2 sec) - to step forward to ALT 2.
- M (< 2 sec) - to step back to Main.



\*Dashes if no previous dive conducted.

Fig. 125 - GAUG SURF ALT 1 (Last dive's data)

**GAUG SURF ALT 2**, information includes (Fig. 126):

- > Altitude graphic (EL - 2 to EL - 7), blank if Sea level.
- > Time of Day (hr:min\_sec) with AM or PM icon if 12 Hour Format, no icon if 24 Hour Format.
- > Temperature with ° icon and graphic F (or C).

- A (< 2 sec) - to step forward to FLY.
- M (< 2 sec) - to step back to ALT 1.

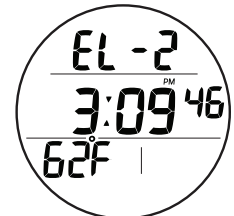

Fig. 126 - GAUG SURF ALT 2

GAUG features a Run Timer which can be selected for display on the Dive Main\*. The Run Timer cannot be added or removed from the display during dives.

*\*When the Run Timer is displayed, max EDT displayed is 99 minutes. When it is not displayed, max EDT displayed is 999 min.*

**GAUG Run Timer Lead-in**, information includes (Fig. 127) -

- > Graphics Goto, GAU, and R.TMR.
- A (< 2 sec) - to access Use Run Timer from Log.
- S (< 2 sec) - to access Use Run Timer.
- A (< 2 sec) - to step forward to SET A.
- M (< 2 sec) - to step back to Log.

**Use Run Timer**, information includes (Fig. 128) -

- > Graphics USE and RTMR.
- > Graphic YES (or NO), flashing.
- A (< 2 sec) - to toggle between YES and NO.
- S (< 2 sec) - to save the selection and revert to Lead-in.
- S (2 sec), if not changed - to revert to Lead-in.



Fig. 127 - GAUG RUN TIMER LEAD-IN



Fig. 128 - USE RUN TIMER

**Upon descent to 5 FT (1.5 M) for 5 seconds,  
operation will enter Gauge Dive Mode.**

**GAUG DIVE MAIN**, information includes (Fig. 129) -

- > Current Depth with FT (or M) icon.
- > Run Timer (min:sec), if selected for display, up to 199:59.
- > Elapsed Dive Time with EDT and min icons, up to 999 if no Run Timer; or up to 99 if the Run Timer is displayed.
- > Tank Pressure with Link, PSI (or BAR), Tank (TMT) icons.
- > Air Time Remaining with ATR and min icons.
- > VARI (while ascending).

- A (< 2 sec) - to access ALT.
- M (2 sec) - to access TMT Switching.
- S (< 2 sec) - to acknowledge/silence alarms.
- S (< 2 sec)\* - to start/stop Run Timer, if displayed.
- S (2 sec)\* - to reset Run Timer to 0:00, if active.
- L (press) - to activate Backlight.

\*S operations of the Run Timer are blocked during Switching and alarms.

Upon ascending to 2 FT (0.6 M) during a dive, Surface Interval time will be displayed with the SURF icon flashing for the first 10 minutes (Fig. 130). The Run Timer will remain active if displayed, then stop and reset to 0:00 after 10 minutes.

- >> Button operations are as described above.
- >> After 10 minutes elapse, operation will revert to the Surface Main and full access will be given to GAUG Surface items.
- >> If a descent is made to 5 FT (1.5 M) for 5 seconds, the dive will be continued.
- >> Surface time will not be added to Dive Time.

**Once a dive is completed in Gauge Mode,  
operation will lock into Gauge Mode for 24 hours.**

**GAUG DIVE ALT**, information includes (Fig. 131) -

- > Max Depth with MAX and FT (or M) icons.
- > Time of Day (hr:min\_sec), with AM (or PM) icon if 12 Hour.
- > Temperature with ° icon and graphic F (or C).

- 5 sec or A (< 2 sec), revert to Main.

**DV 3 (DELAYED VIOLATION 3)**

If you descend deeper than the MOD\*, the audible will sound and the alarm LED will flash. The graphic UP will flash in place of Current Depth (Fig. 132), and Max Depth will only indicate dashes signifying that you are too deep.

*\*MOD is the Max Operating Depth at which the unit can properly perform calculations or provide accurate display information. Refer to the specifications in the back.*

Upon ascending above the MOD, Current Depth will be restored, however, Max Depth will continue to be displayed as dashes for the remainder of that dive. The Log for that dive will also display dashes for Max Depth.

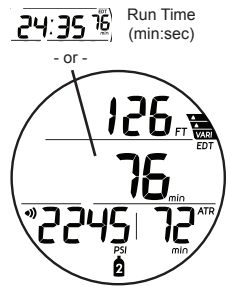

Fig. 129 - GAUG DIVE MAIN

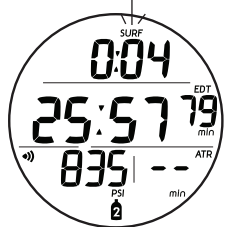

Fig. 130 - GAUG DIVE MAIN (during < 10 min on surface)

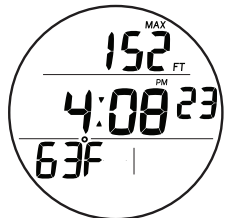

Fig. 131 - GAUG DIVE ALT

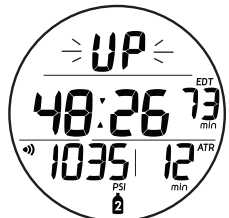

Fig. 132 - GAUG DIVE DV 3



# FREE DIVE OP MODE

**FREE SURF MAIN**, information includes (Fig. 133):

- > Surface Interval time (min:sec up to 59:59, then hr:min) with SURF icon; if no dive, this is time since mode access.
- > Graphic FRE.
- > Dive number with # icon, up to 99 for that operating period (0 if no dive made yet).
- > (PZ+), CF, Battery icons - if they apply.
- > TLBG with icon, if any after a NORM or FREE dive.

- M (2 sec) - to access Watch Main.
- A (< 2 sec) - to step forward to FREE SURF ALT 1.
- M (< 2 sec) - to step back to SHOW NDC.
- L (press) - to activate the Backlight.

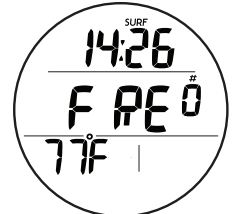

Fig. 133 - FREE SURF MAIN (no dive yet)

Upon surfacing during dives, the Dive Main will remain on display for the first 1 minute (with SI in place of Depth) after which the Surface Main will be displayed.

**FREE SURFACE GROUP**, button operations\* >>

These operations apply to all group selections that follow, those marked with \* are not repeated when describing each selection.

- A (< 2 sec) - to step forward through selections.
- A (hold)\* - to scroll forward through selections.
- M (< 2 sec) - to step back through selections.
- M (2 sec, any time)\* - revert to Main.
- No button action (2 min)\* - revert to Main.
- L (press)\* - to activate the Backlight.

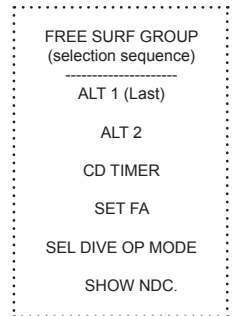

**FREE SURF ALT 1**, information includes (Fig. 134):

- > SI (min:sec, hr:min)\* with SURF icon, prior to Last dive.
- > Max Depth\* with MAX and FT (or M) icons.
- > Elapsed Dive Time\* (min\_sec) with EDT and min\_sec icons.
- > Graphic LAST, indicating data is for previous FREE dive.

\*Dashes if no previous dive conducted while in FREE mode.

- A (< 2 sec) - to step forward to ALT 2.
- M (< 2 sec) - to step back to Main.

**FREE SURF ALT 2**, information includes (Fig. 135):

- > Altitude graphic (EL2 to EL7), blank if Sea level.
- > Time of Day (hr:min\_sec) with AM (or PM) icon if 12 Hour Format, no icon if 24 Hour.

- A (< 2 sec) - to step forward to CDT.
- M (< 2 sec) - to step back to ALT 1.

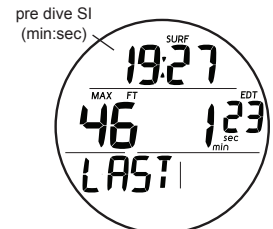

Fig. 134 - FREE SURF ALT 1 (Last Dive's Data)

**CDT (Countdown Timer)**

While on the surface, the CDT can be set, started, and stopped. Once set and started, it continues to run in the background when a dive is started and becomes available as an ALT display.

**CDT Lead-in**, information includes (Fig. 136):

- > Graphics Goto, FRE, and CDT.

- S (< 2 sec) - to access CDT Status.
- A (< 2 sec) - to step forward to SET FA.
- M (< 2 sec) - to step back to ALT 2.

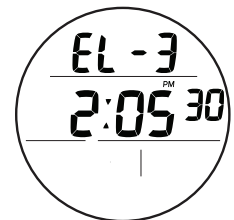

Fig. 135 - FREE SURF ALT 2

**CDT Status**, information includes (Fig. 137):

- > Graphic OFF (or ON) flashing. If OFF, 0:00 or the CDT if previously set. If ON, the remaining CDT (min\_sec) with icons.
- > Graphic CDT.

- A (< 2 sec) - to step forward through selections of OFF, ON, and SET.
- M (< 2 sec) - to step back through selections.
- S (< 2 sec) - to save the selection.

>> If OFF or ON is selected, revert to the Lead-in screen.

>> If SET is selected, access the Set CDT screen.

- S (2 sec) - to revert to CDT Lead-in, if no setting change.



Fig. 136 - CDT LEAD-IN



Fig. 137 - CDT STATUS (On, running)

**Set CDT**, information includes (Fig. 138):

- > Graphics SET and CDT.
- > Timer setting (min\_sec), with Minute digits flashing.
- A (hold) - to scroll upward through Minute Set Points from 0 to 59 (8/sec) in increments of 1 (min).
- A (< 2 sec) - to step upward through Minute Set Points.
- M (< 2 sec) - to step back through Set Points.
- S (< 2 sec) - to save the Minute setting and flash the Seconds digits.
- A (hold) - to scroll upward through Second Set Points from 00 to 59 (8/sec) in increments of 01 (sec).
- A (< 2 sec) - to step upward through Second Set Points.
- M (< 2 sec) - to step back through Set Points.
- S (< 2 sec) - to save the CDT setting and revert to the CDT Status screen with the graphic SET flashing (Fig. 139).
- > ON will then start the countdown and revert to CDT Lead-in.
- > OFF will save the setting and revert to CDT Lead-in.

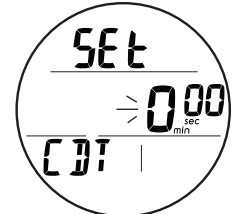

Fig. 138 - SET FREE CDT

When the countdown reaches 0\_00, the audible will sound and the graphic CDT with 0 min will flash on the Main.

**SET FA GROUP (FREE ALARMS)**

Selections >> EDT >> DA1 >> DA2 >> DA3.

Set Points remain as set until changed.

**Set FA Lead-in**, information includes (Fig. 140):

- > Graphics Goto and SET FA.
- A (< 2 sec) - to step forward to Select Dive OP Mode.
- M (< 2 sec) - to step back to CDT.
- S (< 2 sec) - to access Set EDT Alarm.

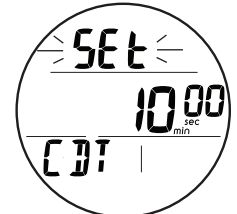

Fig. 139 - CDT STATUS (set, ready)



Fig. 140 - SET FA LEAD-IN

**EDT ALARM**

Factory set for a fixed 30 seconds, the EDT (Elapsed Dive Time) alarm sounds the audible every 30 seconds while underwater in FREE Dive Mode.

**Set EDT Alarm**, information includes (Fig. 141):

- > Graphics SET and EDT AL.
- > Set Point graphic OFF (or ON) flashing.
- A (< 2 sec) - to toggle between ON and OFF.
- S (< 2 sec) - to save the setting and access Set DA 1.
- S (2 sec) - to revert to Set FA.

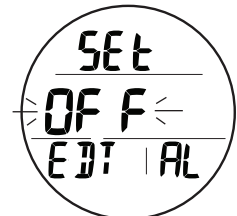

Fig. 141 - SET EDT ALARM

**DA (DEPTH ALARMS)**

There are 3 Free Depth Alarms (DAs) that can be set at progressively deeper depths\*.

\*DA-2's setting must be deeper than DA-1's, and DA-3's must be deeper than DA-2's.

**Set DA-1 Alarm**, information includes (Fig. 142A, B):

- > Graphics SET and DA-1 AL.
- > Set Point graphic OFF, or Depth value with FT (or M) icon, flashing.
- A (hold) - to scroll upward through Set Points (8/sec) from OFF to 30 to 330 FT (10 to 100 M) in increments of 10 FT (1 M).
- A (< 2 sec) - to step upward through Set Points.
- M (< 2 sec) - to step back through Set Points.
- S (< 2 sec) - to save the setting.
- > If OFF is saved, operation reverts to Set FA Lead-in.
- > If a Depth value is saved, Set DA-2 is accessed.
- S (2 sec), if no change - to revert to Set FA Lead-in.



Fig. 142A - SET DA



Fig. 142B - SET DA (depth value)

Set DA-2 and DA-3 are similar with Depth values beginning 1 increment higher (deeper) than the previous selection set.

Example : If DA-1 is set for 100 FT, DA-2 settings start at 110 FT.

**SELECT DIVE OP MODE** >> similar to NORM.

**SHOW NDC TIME**

This selection allows NDC (No Deco time remaining) to be displayed on the Dive Main in addition to EDT.

**NDC Lead-in**, information includes (Fig. 143):

- > Graphics Goto, SHOW, and NDC.
- S (< 2 sec) - to access Show NDC.
- A (< 2 sec) - to step forward to Surface Main.
- M (< 2 sec) - to step back to Select Dive OP Mode.

**Show NDC**, information includes (Fig. 144):

- > Graphic YES (or NO) flashing.
- > Graphics SHOW and NDC with icon.
- A (< 2 sec) - to toggle between YES and NO.
- S (< 2 sec) - to save the setting and revert to Lead-in.
- S (2 sec) - to step back to Lead-in, if no setting change.

**Shared Settings >> To change items that FREE Mode shares with NORM Mode, access NORM SURF Main, then Set U, then Set Wet Activation, Units, Algorithm, CF, or Glo.**

**Upon descent to 5 FT (1.5 M) for 5 seconds, operation will enter Free Dive Mode.**

**FREE DIVE MAIN**, information includes (Fig. 145) -

- > Current Depth with FT (or M) icon.
- > Elapsed Dive Time with EDT and min\_sec icons >>
- >> when NDC is not displayed (Fig. 145A), EDT will be shown as seconds only up to 59 sec, then minutes and seconds up to 199 min\_59 sec.
- >> when NDC is displayed (Fig. 145B), EDT will be shown as seconds only up to 59 sec, then minutes only up to 199 min.
- > NDC (up to 999 min) with icon, if set On.
- > Temperature with ° icon and graphic F (or C).
- > TLBG with icon.
- > (PZ+), CF icons - if they apply

- A (< 2 sec) - to access ALT.
- L (press) - to activate Backlight.

Upon ascending to 2 FT (0.6 M) during a dive, Surface Interval time will be displayed with the SURF icon flashing for the first 1 minute and NDC (if set On) will be displayed as 2 dashes.

- A (< 2 sec) - to access Dive ALT.
- > After 1 minute elapses, operation will revert to Surface Mode with full access given to other FREE Surface items.
- > If a descent is made to 5 FT (1.5 M) for 5 sec, the dive will be continued. Surface time will not be added to Dive Time.

**FREE DIVE ALT**, information includes (Fig. 146) -

- > Max Depth with MAX and FT (or M) icons.
- > Remaining Countdown Time (min:sec with colon flashing) if On and a CD is in progress, or 0:00 with colon flashing if On and the CD is complete. If Off, the CD Time previously set is displayed with colon solid indicating it is ready to start.
- > Graphics CDT and ON (flashing).
- S (< 2 sec) - to toggle between ON and OFF\*.

- A (< 2 sec) - to revert to Main.
- Revert to Main in 10 sec, if A is not pressed.
- L (press) - to activate Backlight.

When ON, the CDT will run in the background until it counts down to 0:00, or it is turned Off.



Fig. 143 - SHOW NDC LEAD - IN (to access Show)



Fig. 144 - SHOW NDC (to show on Main)

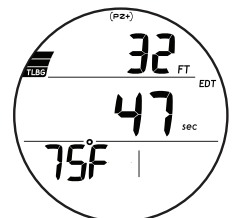

Fig. 145A - FREE DIVE MAIN

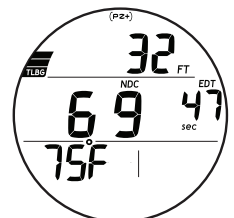

Fig. 145B - FREE DIVE MAIN (with Show NDC set ON)

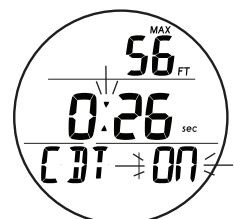

Fig. 146 - FREE DIVE ALT (CDT On, running)

\*Start or Stop the countdown and revert to Main.

**FREE DIVE ALARMS**

FREE mode alarms, which are separate from NORM (or GAUG) alarms, sound either 1 or 3 times as 3 beeps then clear.

They cannot be acknowledged or silenced.

**FREE CDT Alarm**

When a set Countdown Time reaches 0, the audible will sound during which time the graphic CDT will be displayed with 0 min flashing on the Main (Fig. 147).

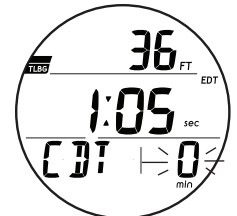

Fig. 147 - CDT AL

**FREE EDT Alarm**

When set On, the EDT alarm activates every 30 seconds during a dive. The audible will sound during which time the EDT digits will flash on the Main (Fig. 148).



Fig. 148 - EDT AL

**FREE Depth Alarms**

When set On, the Depth alarms (1, 2, 3) activate at their respective set Depths. The audible will sound during which time the graphic DA1 (2, 3) will be displayed with the Depth digits flashing on the Main (Fig. 149).

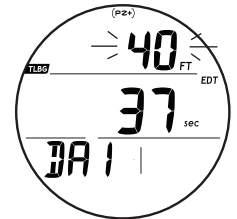

Fig. 149 - DEPTH AL

**High Nitrogen Alarms**

When nitrogen increases to the caution level (4 TLBG segments), the audible will sound during which time the TLBG segments will flash on the Main (Fig. 150).

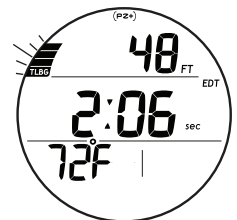

Fig. 150 - FREE TLBG AL (during audible)

In the event that nitrogen continues to increase and reaches the Deco level, the audible will sound again during which time all 5 TLBG segments and the graphic VIO will flash (in place of Temperature), and NDC will be removed.

When the audible is silent, the TLBG will be removed, the graphic UP will alternate with VIO (Fig. 151) until on the surface, then UP will be removed.

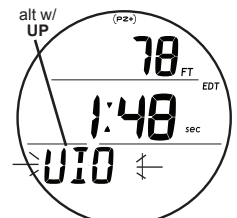

Fig. 151 - FREE VIOLATION (after audible)

The graphic VIO flashes until 1 minute elapses on the surface, then it shifts upward and alternates with FRE (Fig. 152) and operation reverts to Violation Gauge Mode for 24 hours.

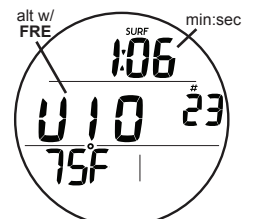

Fig. 152 - FREE VIOLATION (after 1 min on surface)

# REFERENCE

## PC INTERFACE

The unit is configured with a Data Port (Fig. 153a) that enables it to be connected to a PC USB port using a special interface cable that is available as an optional accessory.

The USB Driver required for the PC interface system can be downloaded from the Oceanic Worldwide web site.

The PC interface system can be used to set/change the Set T group (Watch Time/Date), Set A group (Alarms), Set U group (Utilities), and Set FA group (FREE Alarms). The Set F group (FO2) settings and Dive Operating Mode selection must be entered using the button controls.

Information available for retrieval\* (download) from the unit to the PC program includes items such as dive number, surface interval time, depth, dive time, start date and time, lowest temperature, sampling rate, Set Points, TLBG, VARI, air time, start/end pressure, and Gas/TMT Switching events.

\*FREE Dive information is only available using the PC interface system.

The unit checks for the presence of an interface device connection to the Data Port once every second\* while in Watch mode.

\*Checks are not made if the Wet Activation contacts are wet.

Upon sensing an interface connection, the requesting device (PC) connects to the ATOM and is prepared for upload of settings or download of data which is then initiated using the PC program. During the process, there is a 2 minute window during which time a PC countdown screen is displayed on the ATOM (Fig. 154). Upload or download must be started during this time.

Prior to attempting to download data from your ATOM or upload settings to it, review the HELP section of the interface program. Recommended is to print those sections of HELP that you consider appropriate for your interface activities.

### PC requirements:

- IBM<sup>®</sup>, or compatible, PC with USB Port
- Intel<sup>®</sup> Pentium 200 MHz or better microprocessor
- Microsoft<sup>®</sup> Windows<sup>®</sup> 2000, XP, Vista, or 7
- Super VGA card or compatible video graphics adaptor (256 color or greater) with a minimum 800 X 600 pixel screen area of display settings
- 16MB of available RAM
- 20MB of available hard drive storage
- Mouse
- CD Rom drive
- Printer

For software updates, refer to the Oceanic web site at ->> [www.OceanicWorldwide.com](http://www.OceanicWorldwide.com)

For support, call OceanLog Support toll free at ->> (866) 732-7877, 8 Am to 5 Pm USA Pacific time.

## CARE AND CLEANING

Protect your unit from shock, excessive temperatures, exposure to chemicals, and tampering. Protect the lens against scratches with a Instrument Lens Protector. Small scratches will naturally disappear underwater.

- Soak and rinse the unit in fresh water at the end of each day of diving, and check to ensure that the areas around the Low Pressure (Depth) Sensor (Fig. 155a), PC Interface Data Port (Fig. 155b), and buttons are free of debris or obstructions.
- To dissolve salt crystals, use lukewarm water or a slightly acidic bath (50% white vinegar/50% fresh water). After removal from the bath, place the unit under gently running fresh water and towel dry before storing.
- Transport your equipment cool, dry, and protected.

## INSPECTIONS AND SERVICE

Your dive computer should be inspected annually by an Authorized Oceanic Dealer who will perform a factory prescribed function check and inspection for damage or wear. To keep the 2 year limited warranty in effect, this inspection must be completed one year after purchase (+/- 30 days).

Oceanic recommends that you continue to have an inspection performed every year to ensure it is working properly. The costs of annual inspections, or inspections relating to water tight integrity, are not covered under the terms of the 2 year limited warranty.

### To Obtain Service:

Take your unit to your local Authorized Oceanic Dealer.

If required to return your unit to the Oceanic USA factory:

- Obtain an RA (Return Authorization) number by contacting Oceanic USA at 510/562-0500 or send an e-mail to [service@oceanicusa.com](mailto:service@oceanicusa.com).
- Record all dive data in the Log and/or download the data stored in memory. All data will be erased during factory service.
- Package it using a protective cushioning material.
- Include a legible note stating the specific reason for return, your name, address, daytime phone number, serial number(s), and a copy of your original sales receipt and Warranty Registration.
- Send freight prepaid and insured using a traceable method.
- Non-warranty service must be prepaid. COD is not accepted.
- Additional information is available on the Oceanic web site [OceanicWorldwide.com](http://OceanicWorldwide.com) or on the local Oceanic web site that serves your global region.

**The procedures that follow must be closely adhered to. Damage due to improper battery replacement is not covered by the unit's warranty.**

**When the battery is removed, settings and calculations for repetitive dives are retained in the unit's memory while a new battery is installed.**

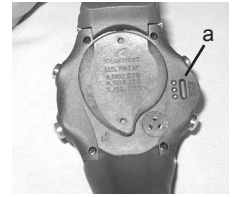

Fig. 153 - DATA PORT

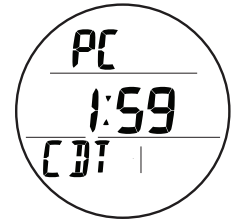

Fig. 154 - PC INTERFACE

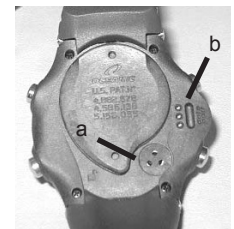

Fig. 155 - CASE BACK

**BATTERY REPLACEMENT**

The Battery Compartment should only be opened in a dry and clean environment with extreme care taken to prevent the entrance of moisture or dust.

As an additional precautionary measure to prevent formation of moisture in the Battery Compartment, it is recommended that the Battery be changed in an environment equivalent to the local outdoor temperature and humidity (e.g., do not change the Battery in an air conditioned environment then take it outside during a hot sunny day).

Inspect the Buttons, Lens, and Housing to ensure they are not cracked or damaged. If there is any sign of moisture in the Housing, DO NOT attempt to use it for diving until it receives proper service by an authorized Oceanic facility.

**Battery Removal**

- Locate the Battery Compartment on the back of the unit.
- Rotate the Battery Cover clockwise 10 degrees using the special Battery Cover Tool (Fig. 156A), or by pushing the lower portion to the left while pushing the upper portion to the right using your thumbs (Fig. 156B).
- Lift the Cover with O-ring up and away from the Housing.
- Using care not to damage the Contact (Fig. 157a), slide the Battery up and out of the left side of the Compartment.
- Discard the Battery according to local regulations governing disposal of Lithium batteries.

**CAUTION:** DO NOT allow a metal object to short circuit the top of the Battery, which is positive (+), to the negative ( - ) contact of the Battery Compartment.

**Inspection**

- Closely check all of the sealing surfaces for any signs of damage that might impair proper sealing.
- Inspect the Buttons, Lens, and Housing to ensure they are not cracked or damaged.
- Remove the Battery Cover O-ring and inspect it for any signs of deterioration or deformity. DO NOT use tools to remove the O-ring.
- To ensure proper sealing, O-ring replacement is highly recommended each time the Battery is replaced.
- Closely examine the threads of the Battery Cover and Housing for any signs of damage that might prevent proper threading.
- Closely examine the inside of the Battery Compartment for any signs of corrosion indicating entrance of moisture into the unit.

**WARNING:** If damage, moisture, or corrosion is found, return your unit to an Authorized Oceanic Dealer, and DO NOT attempt to use it until it has received factory prescribed service.

**Battery Installation**

- Slide a new 3 volt type CR2430 Lithium Battery, negative side down into the Battery Compartment. Slide it in from the left side (Fig. 158) and ensure that it slides under the contact clip on the lower/right rim of the cavity.
- Lightly lubricate the new Cover O-ring\* with silicone grease and place it on the inner rim of the Battery Cover. Ensure that it is evenly seated (Fig. 159).

*\*The O-ring must be a genuine Oceanic part that can be purchased from an Authorized Oceanic Dealer. Use of any other O-ring will void the warranty.*

- Carefully place the Battery Cover (with O-ring) into position on the rim of the Battery Compartment, then press it evenly and completely down into place.
- Maintain the Battery Cover securely in place and turn it counter clockwise 10 degrees using the special Battery Cover tool (Fig. 160A), or by pushing the lower portion to the right while pushing the upper portion to the left (Fig. 160B).

**Testing**

- Observe the LCD display to ensure it is consistently clear and sharp in contrast throughout the screen.
- Set the Date and Time.
- Verify all Set Points prior to diving.

**If any portions of the display are missing or appear dim, or if a Low Battery Condition is indicated, return your unit to an Authorized Oceanic Dealer for a complete evaluation before attempting to use it.**



Fig. 156A - COVER REMOVAL (using tool)



Fig. 156B - COVER REMOVAL (using thumbs)

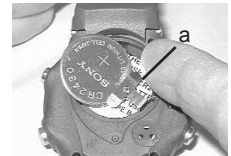

Fig. 157 - BATTERY REMOVAL



Fig. 158 - BATTERY INSTALL



Fig. 159 - COVER O-RING



Fig. 160A - COVER INSTALL (using tool)



Fig. 160B - COVER INSTALL (using thumbs)



### ALTITUDE SENSING AND ADJUSTMENT

Altitude (i.e., ambient pressure) is measured upon activation and every 15 minutes until a dive is made.

- > Measurements are only taken when the unit is dry.
- > Two readings are taken, the second reading 5 seconds after the first. The readings must be within 1 foot (30 cm) of each other to record that ambient pressure as the current Altitude.
- > No adjustments are made during any time that the Wet Contacts are bridged.
- > When diving in high altitude waters from 3,001 to 14,000 feet (916 to 4,270 meters), the unit automatically adjusts to these conditions providing adjusted Depth, and allowed Dive Times at intervals of 1,000 feet (305 meters).
- > When the Conservative Factor is set On, allowed Dive Times are calculated based upon the next higher 3,000 foot (915 meter) Altitude.
- > At Sea Level, calculations are based upon an Altitude of 6,000 feet.
- > All adjustments for Altitudes greater than 11,000 feet (3,355 meters) are then made to allowable dive times for 14,000 feet (4,270 meters).
- > The unit will not function as a dive computer above 14,000 feet (4,270 meters).

### ADDITIONAL INFORMATION PERTAINING TO FREE DIVE MODE

- Although breathing apparatus is not utilized for Free Dive activities, nitrogen tissue loading remains a factor. Nitrogen loading is calculated based upon a fixed FO<sub>2</sub> of Air.
- Since a user has the option of alternating between SCUBA and Free Dive activities within a 24 hour period, nitrogen calculations and the displayed value of No Deco Dive Time Remaining (NDC time) are carried over from one operating mode to the other, which permits the user to maintain awareness of nitrogen absorption and offgassing status.
- The mathematical models currently used in this dive computer are based on no decompression/decompression multilevel repetitive dive schedules.
- These algorithms do not take into account the physiological changes associated with the high pressures that competitive type Free diving can expose a diver to.



### ADDITIONAL WARNINGS

- **Ensure that you know which Operating Mode is selected (NORM, GAUG, or FREE) prior to commencing any dive.**
- **Conducting Free dives within a 24 hour period after conducting SCUBA dives, combined with the effects of multiple rapid Free Dive ascents, increases your risk of decompression sickness. Such activities may result in accelerated entry into decompression which could cause serious injury or death.**
- **Combining competitive type Free dive activities that involve multiple descents/ascents with activities utilizing SCUBA during the same 24 hour period is not recommended. Presently, there is no data relating to such activities.**
- **It is highly recommended that anyone planning to become involved in competitive type Free dive activities obtain proper instruction and training from a recognized Free Diving trainer. It is imperative that the physiological affects be understood and the diver is physically prepared.**

# TECHNICAL DATA

**PZ+ ALGORITHM >> NDLS (minutes) at ALTITUDE (Imperial)**

Altitude (feet)	0 to 3000	3001 to 4000	4001 to 5000	5001 to 6000	6001 to 7000	7001 to 8000	8001 to 9000	9001 to 10000	10001 to 11000	11001 to 12000	12001 to 13000	13001 to 14000
Depth (FT)												
30	197	150	141	134	128	122	117	112	107	99	94	89
40	109	81	75	71	68	65	62	60	57	55	53	51
50	65	53	51	49	47	44	42	39	37	35	34	33
60	48	37	35	33	32	30	28	26	24	23	22	21
70	35	26	24	23	21	20	19	18	17	16	16	14
80	26	19	18	17	16	15	14	13	12	11	11	10
90	19	15	14	13	12	11	10	10	9	9	8	8
100	16	11	10	10	9	9	8	8	7	7	7	7
110	12	9	8	8	8	7	7	7	6	6	6	5
120	10	8	7	7	7	6	6	6	5	5	5	5
130	8	7	6	6	6	5	5	5	5	5	4	4
140	7	6	5	5	5	5	5	4	4	4	4	4
150	6	5	5	5	5	4	4	4	4	4	4	3
160	6	5	5	4	4	4	4	4	4	3	3	3
170	5	4	4	4	4	4	3	3	3	3	3	3
180	5	4	4	4	3	3	3	3	3	3	3	3
190	4	4	4	3	3	3	3	3	3	3	3	3

**PZ+ ALGORITHM >> NDLS (minutes) at ALTITUDE (Metric)**

Altitude (meters)	0 to 915	916 to 1220	1221 to 1525	1526 to 1830	1831 to 2135	2136 to 2440	2441 to 2745	2746 to 3050	3051 to 3355	3356 to 3660	3661 to 3965	3966 to 4270
Depth (M)												
9	217	161	151	143	136	130	124	119	104	110	103	97
12	115	87	81	75	72	68	65	63	60	58	55	54
15	68	55	53	51	49	47	44	42	39	37	36	34
18	50	39	37	35	33	32	30	28	26	24	23	22
21	36	28	26	24	23	21	20	19	18	17	16	16
24	27	20	19	18	17	16	15	14	13	12	11	11
27	20	16	15	13	12	11	11	10	9	9	9	8
30	16	12	11	10	9	9	9	8	8	7	7	7
33	13	9	9	8	8	7	7	7	7	6	6	6
36	10	8	7	7	7	6	6	6	5	5	5	5
39	9	7	6	6	6	6	5	5	5	5	5	4
42	8	6	6	5	5	5	5	5	4	4	4	4
45	6	5	5	5	5	4	4	4	4	4	4	4
48	6	5	5	4	4	4	4	4	4	3	3	3
51	5	4	4	4	4	4	4	3	3	3	3	3
54	5	4	4	4	4	3	3	3	3	3	3	3
57	5	4	4	3	3	3	3	3	3	3	3	3

**DSAT ALGORITHM >> NDLS (minutes) at ALTITUDE (Imperial)**

Altitude (feet)	0 to 3000	3001 to 4000	4001 to 5000	5001 to 6000	6001 to 7000	7001 to 8000	8001 to 9000	9001 to 10000	10001 to 11000	11001 to 12000	12001 to 13000	13001 to 14000
Depth (FT)												
30	260	201	187	175	165	156	148	141	135	130	124	118
40	137	103	96	90	85	80	76	72	69	66	63	61
50	81	63	60	58	55	52	48	45	43	41	39	37
60	57	43	40	38	36	34	33	31	30	29	28	27
70	40	31	30	28	27	26	24	23	22	20	19	18
80	30	24	23	21	20	19	18	17	16	16	14	13
90	24	19	18	17	16	15	14	13	12	11	10	10
100	19	15	14	13	12	11	10	10	9	9	8	8
110	16	12	11	10	9	9	8	8	8	7	7	7
120	13	9	9	8	8	8	7	7	7	6	6	6
130	11	8	8	7	7	7	6	6	6	6	5	5
140	9	7	7	6	6	6	6	5	5	5	5	5
150	8	6	6	6	5	5	5	5	5	4	4	4
160	7	6	5	5	5	5	4	4	4	4	4	4
170	7	5	5	5	4	4	4	4	4	4	4	3
180	6	5	5	4	4	4	4	4	4	3	3	3
190	5	4	4	4	4	4	3	3	3	3	3	3

**DSAT ALGORITHM >> NDLS (minutes) at ALTITUDE (Metric)**

Altitude (meters)	0 to 915	916 to 1220	1221 to 1525	1526 to 1830	1831 to 2135	2136 to 2440	2441 to 2745	2746 to 3050	3051 to 3355	3356 to 3660	3661 to 3965	3966 to 4270
Depth (M)												
9	283	217	204	190	178	168	159	151	144	138	132	127
12	144	112	104	97	90	85	81	77	73	70	67	64
15	85	66	63	60	57	55	52	49	46	43	41	39
18	59	45	42	40	38	36	34	32	31	30	29	28
21	41	33	31	29	28	27	26	24	23	21	20	19
24	32	26	24	22	21	20	19	18	17	16	15	14
27	25	19	18	17	16	16	14	13	12	12	11	10
30	20	16	15	13	12	12	11	10	10	9	9	8
33	17	12	11	11	10	9	9	8	8	8	7	7
36	14	10	9	9	8	8	7	7	7	6	6	6
39	11	8	8	7	7	7	6	6	6	6	5	5
42	9	7	7	6	6	6	6	5	5	5	5	5
45	8	6	6	6	5	5	5	5	5	5	4	4
48	7	6	6	5	5	5	4	4	4	4	4	4
51	6	5	5	5	4	4	4	4	4	4	4	4
54	6	5	5	4	4	4	4	4	4	3	3	3
57	5	4	4	4	4	4	3	3	3	3	3	3

**SPECIFICATIONS**

**CAN BE USED AS**

- Watch
- Dive Computer (Air or Nitrox) with up to 3 Gases up to 100% O2 and 3 Transmitters.
- Digital Depth Gauge/Timer with up to 3 Transmitters.
- Free Dive (breath hold) activity with Depth Gauge/Countdown Timer.

**DIVE COMPUTER PERFORMANCE**

- Buhlmann ZHL-16c based PZ+, or DSAT based, algorithm.
- No Deco limits closely follow PADI RDP.
- Decompression in agreement with Buhlmann ZHL-16c and French MN90.
- No Deco Deep Stops >> Morroni, Bennett.
- Deco Deep Stops (not recommended) >> Blatteau, Gerth, Gutvik.
- Altitude >> Buhlmann, IANTD, RDP (Cross).
- Altitude corrections and O2 limits based on NOAA tables.

**TRANSMITTERS**

- Battery and Pressure check
  - > every 2 minutes when asleep
  - > every 2 seconds when awake
- Startup
  - > Pressure => 120 PSI (8 BAR)
  - > Battery => 2.75 volts
- Shutdown
  - > Pressure < 50 PSI (3.5 BAR)

**TMT Compatibility with Nitrox**

When packaged and shipped from the factory, Oceanic TMTs are rated for use with compressed Air and Nitrox mixtures containing up to 99% O2 by volume and with 100% O2.

**OPERATIONAL PERFORMANCE**

Function:	Accuracy:
• Depth	±1% of full scale
• Timers	1 second per day

**Dive Mode Activation:**

- Must be in Dive Computer mode, if Wet Activation is set OFF.
- Automatic by immersion in water, if Wet Activation is set ON.
- Cannot be manually activated deeper than 4 FT (1.2 M), if Wet Activation is set OFF.
- Cannot operate as a DC at elevations higher than 14,000 feet (4,270 meters).

**Dive Counter:**

- NORM/GAUG displays Dives #1 to 24, FREE displays #1 to 99 (0 if no dive made yet).
- Resets to Dive #1, upon diving (after 24 hours with no dives).

**Dive Log Mode:**

- Stores 24 most recent NORM/GAUG dives in memory for viewing.
- After 24 dives, adds 25th dive in memory and deletes the older dive.

**Altitude:**

- Operational from sea level to 14,000 feet (4,270 meters) elevation.
- Measures ambient pressure every 30 minutes in Watch mode, when Dive Computer mode is accessed, and every 15 minutes while in DC Surface modes.
- Does not measure ambient pressure when Wet.
- Compensates for Altitudes above sea level beginning at 3,001 feet (916 meters) elevation and every 1,000 feet (305 meters) higher.

**Power:**

- Watch Battery (1) 3 vdc, CR2450, Lithium battery (Panasonic or equivalent)
- Transmitter Battery (1) 3 vdc, CR2, .75 Ahr, Lithium battery (Duracell model DL-CR2 or equivalent)
- Shelf life Up to 7 years (when shipped from factory in Deep Sleep mode)
- Replacement User replaceable (annual recommended)
- Use Life (ATOM 3.0) 1 year or 300 dive hours if (2) 1 hour dives per dive day
- Use Life (Transmitter) 300 dive hours if (2) 1 hour dives per dive day

**Battery Indicator (ATOM 3.0 only):**

- Warning >> icon on solid when <= 2.75 volts, Battery change recommended.
- Alarm >> icon on flashing when <= 2.50 volts, change the Battery, will not function as a DC.

**Operating Temperature:**

- Out of the water >> between 20 °F and 140 °F (-6 and 60 °C).
- In the water >> between 28 °F and 95 °F (-2 and 35 °C).

**BAR GRAPHS:**

TLBG	segments
• No Deco Normal zone	1 to 3
• No Deco Caution zone	4
• Decompression zone	5 (all)

VARI	60 FT (18 M) & Shallower			Deeper than 60 FT (18 M)		
	segments	FPM	MPM	segments	FPM	MPM
	0	0 - 10	0 - 3	0	0 - 20	0 - 6
• Normal zone	1	11 - 15	3.5 - 4.5	1	21 - 30	6.5 - 9
• Normal zone	2	16 - 20	5 - 6	2	31 - 40	9.5 - 12
• Normal zone	3	21 - 25	6.5 - 7.5	3	41 - 50	12.5 - 15
• Caution zone	4	26 - 30	8 - 9	4	51 - 60	15.5 - 18
• Too Fast zone (flashing)	5 (all)	> 30	> 9	5 (all)	> 60	> 18

SPECIFICATIONS (CONTINUED)

NUMERIC DISPLAYS:	Range:	Resolution:
• Main Time of Day	00:00_00 to 23:59_59 hr:min_sec	1 second
• Dual Time of Day	00:00 to 23:59 hr:min	1 minute
• Dual Time Differential	- 23 hr to 0 to + 23 hr	1 hour
• Watch Countdown Timer	23:59 to 0:00 hr:min	1 minute
• Watch Chrono Lap #	1 to 9	1 (lap)
• Watch Chrono Lap Time	0:00 to 1:59:59_99 (hr:min:sec_01 sec)	.01 second
• PCI Countdown Timer	1:59 to 0:00 min:sec	1 second
• Altitude Level	Sea, EL-2 to EL-7	1 (level)
• Time to Fly	23:50 to 0:00 hr:min (starting 10 min after the dive)	1 minute
• Time to Desaturate	23:50 to 0:00 hr:min (starting 10 min after the dive)	1 minute
• Temperature	0 to 99°F (-18 to 60°C)	1°F (C)
• Depth (display)	0 to 330 FT (100 M)	1 FT (0.1/1 M)
• Max Operating Depth	330 FT (100 M)	
• Tank Pressure	0 to 5000 PSI (345 BAR)	5 PSI (1 BAR)
• NORM/GAUG SI Time	0:00 to 23:59 hr:min	1 minute
• NORM/GAUG Dive Number	0 to 24	1 (dive)
• NORM EDT	00 to 199 min	1 minute
• GAUG EDT (with Run Time)	00 to 99 min	1 minute
• GAUG EDT (without Run Time)	00 to 999 min	1 minute
• NORM DTR (NDC, OTR)	0 to 199 min	1 minute
• NORM/GAUG ATR	0 to 199 min	1 minute
• FO2 (1, 2, 3) Set Points	Air, 21 to 100 %	1 %
• PO2 Value	0.00 to 5.00 ATA	.01 ATA
• O2 Saturation	0 to 100 %	1 %
• No Deco Deep Stop Time	2:00 to 0:00 min:sec	1 second
• No Deco Safety Stop Time	5:00 to 0:00 min:sec	1 second
• Safety Stop Run Timer	0:00 to 9:59 min:sec	1 second
• GAUG Dive Run Timer	0:00 to 199:59 min:sec	1 second
• Deco Stop Time	1 to 99 min	1 minute
• Total Ascent Time	1 to 199 min	1 minute
• Violation Countdown Timer	23:50 to 0:00 hr:min	1 minute
• FREE SI Time (< 1 hr)	0:00 to 59:59 min:sec	1 second
• FREE SI Time (=> 1 hr)	1:00 to 23:59 hr:min	1 minute
• FREE Dive Number	0 to 99	1
• FREE Countdown Timer	59:59 to 0:00 min:sec	1 second
• FREE EDT (< 1 min)	0 to 59 sec	1 second
• FREE EDT (=> 1 min, no NDC)	1_00 to 59_59 min_sec	1 second
• FREE EDT (=> 1 min, with NDC)	1 to 59 min	1 minute



**WARNING: If your ATOM 3.0 stops working for any reason while operating as a Dive Computer, it is important that you have anticipated this possibility and are prepared for it. This is an important reason for not pushing the no decompression and oxygen exposure limits, and a critical reason to avoid entering decompression.**

**If you dive in situations where your trip would be ruined or your safety would be jeopardized by losing the use of your ATOM 3.0, a backup instrument system is highly recommended.**

FCC ID: MH8A

**FCC COMPLIANCE:**

This equipment complies with Part 15 of the FCC Rules. Operation is subject to the following two conditions: 1.) this equipment may not cause harmful interference, and 2.) this equipment must accept any interference received, including interference that may cause undesired operation.

**FCC INTERFERENCE STATEMENT:**

This equipment has been tested and found to comply with the limits for an Intentional Radiator, a Class B Digital Device, pursuant to Part 15 of FCC Rules, Title 47 of the Code of Federal Regulations. These rules are designed to provide reasonable protection against harmful interference in a commercial or residential installation. This equipment generates, uses and can radiate radio frequency energy and, if not installed and used in accordance with the instructions, may cause harmful interference to radio communications.

There is no guarantee that interference will not occur in a particular installation. If this equipment does cause interference to radio or television reception, which can be determined by turning the equipment off and on, the user is encouraged to try to correct the interference by one or more of the following measures:

- Reorient or relocate the receiving antenna.
- Increase the separation between the equipment and receiver.
- Connect the equipment to an outlet on a circuit different from that to which the receiver is connected.
- Consult the dealer or an experienced radio/TV technician.



**Warning: Changes or modifications to this unit not expressly approved by Oceanic/2002 Design could void the user's authority to operate the equipment.**

**INSPECTION / SERVICE RECORD**

ATOM 3.0 Serial Number: \_\_\_\_\_

ATOM 3.0 Firmware Rev: \_\_\_\_\_

Transmitter1 Serial Number: \_\_\_\_\_

Transmitter 2 Serial Number: \_\_\_\_\_

Transmitter 3 Serial Number: \_\_\_\_\_

Date of Purchase: \_\_\_\_\_

Purchased from: \_\_\_\_\_

Below to be filled in by an Authorized Oceanic Dealer:

Date	Service Performed	Dealer/Technician

**OCEANIC WORLD WIDE**

OCEANIC USA  
 2002 Davis Street  
 San Leandro, CA 94577  
 Tel: 510/562-0500  
 Fax: 510/569-5404  
 Web: www.OceanicWorldwide.com  
 E-mail: hello@oceanicusa.com

OCEANIC EUROPE  
 Augsburg, Germany  
 Tel: +49 (0) 821 810342 0 Fax: +49 (0) 821 810342 29  
 Web: www.oceanic-eu.com  
 E-mail: office@oceanic.de

OCEANIC ASIA PACIFIC  
 Singapore  
 Tel: +65-6391-1420 Fax: +65-6297-5424  
 E-mail: info@oceanicasia.com.sg

OCEANIC UK  
 Devon, United Kingdom  
 Tel: (44) 1404-891819 Fax: +44 (0) 1404-891909  
 Web: www.OceanicUK.com  
 E-mail: helpyou@oceanicuk.com

OCEANIC HAWAII and MICRONESIA  
 Kapolei, Hawaii  
 Tel: 808-682-5488 Fax: 808-682-1068  
 E-mail: lbell@oceanicusa.com

OCEANIC AUSTRALIA  
 Rosebud, Victoria, Australia  
 Tel: 61-3-5986-0100 Fax: 61-3-5986-1760  
 Web: www.OceanicAUS.com.au  
 E-mail: sales@OceanicAUS.com.au

---

NOTES

# **ATOM 3.0**

## **DIVE COMPUTER**

### **OPERATING MANUAL**